

cowie[®]

PTFE

**Laboratory
Products**



www.cowie.com

The worlds leading specialist for the design and manufacture of PTFE Laboratory Products, including:-

PTFE Labware

and **PTFE Process Chemistry Equipment**

PTFE used in the manufacture of COWIE® PTFE Laboratory Products is pure, virgin material which conforms to FDA and USP Class VI requirements.

PTFE is the material of choice for -

■ **Chemical Resistance**

The chemical resistance of PTFE is almost total over its working temperature range. Reaction is limited to some compounds with free electrons such as sodium in liquid ammonia and some fluorine compounds at high temperature and pressure. Halogens will penetrate PTFE but without apparent reaction.

■ **Thermal Stability**

The thermal stability of PTFE is outstanding. The material can be used to ca. 280°C yet there is no embrittlement in liquid helium. Thermal degradation does not commence until about 400°C. PTFE does not melt to form a liquid phase.

■ **Insolubility & Purity**

The PTFE we use conforms to USP Class VI and FDA requirements and is intrinsically pure and contains no additives. PTFE is insoluble in all known solvents except under extremes of pressure and temperature and will not contaminate media by dissolution.

■ **Sterilisation**

PTFE can be sterilised by all usual means except gamma radiation.

Standard products are available throughout the world from major laboratory product distributors. If you have difficulty obtaining our products, require technical assistance or the manufacture of a custom item, please contact us.

All dimensions are nominal.

Serving Europe, Africa, Asia & Australasia

Cowie Technology Group Ltd
Ridgeway, Coulby Newham
Middlesbrough, TS8 0TQ
England
Tel: + 44 (0) 1642 599190
Fax: + 44 (0) 1642 596810
Email: enquiries@cowie.com

Serving USA & Canada

Cowie Technology Corp
PO Box 6036
330 Water Street, Suite 105,
Wilmington, DE 19804
USA
Toll Free: 800 233 5711
Tel: 001 302 998 7037
Fax: 001 302 998 7092
Email: inquiries@cowie.com



PTFE Containers			P02-07
Beaker Covers	Beakers	Bottles	
Crucibles	Custom Containers	Dipper Beakers	
Evaporating Dishes	Jars	Ladles	
Round Bottom Flasks	Test Tubes	Test Tube Racks	
Thermotech Beakers	Vials & Dropping Bottles		
PTFE Jointware			P08-13
Compression Fittings for Standard Taper Joints	Custom Jointware	Flexible Bellows	
Joint Adapters	Joint Clamps	Rigid Sleeves	
Round Bottom Flasks	Thin Wall Sleeves	Stoppers	
PTFE Connectors, Valves & Stopcocks			P14-17
Connectors	Stopcocks	Tubing	
Valves			
PTFE Handling Products			P18-19
Bottle Pourers	Custom Handling Products	Funnels	
Scoop	Spatulas	Tissue Grinders/ Homogenisers	
Tweezers			
PTFE Stirrer Bars			P20-33
Stirrer Bar Retrievers	Stirrer Bars	Stirring Rods	
PTFE Shaft Stirring			P34-41
Adjustable Rotors	Custom Shaft Stirring	HP Shaft Guide	
Shaft Stirrers	Stirrer Blades	Universal Stirrer Guide	
PTFE Reactor Lids & Fittings			P42-53
Baffles	Blanking Lids	Blanking Nuts	
Custom Reactor Lids	Extension Adapters	HP Shaft Guide with NPT Thread	
NPT Compression Fittings & Replacement Parts	Pre-assembled Reactor Lids	Self Assembly Reactor Lids	
Standard Taper Joints	Universal Stirrer Guide with NPT Thread		
PTFE Temperature Probes			P54-57
Baffle	Custom Probes	Platinum Resistance	
Thermocouple	Total Immersion		
PTFE Technical Information			P58-59
Custom Manufacture			P60
How to Order			P61



Certificate number 4003393

Cowie Technology Group Ltd designs and manufactures under BS EN ISO9001:2008. Certified by Lloyd's Register Quality Assurance.

In the interest of product development Cowie Technology reserve the right to alter product specifications without notice. ©2012. No part of this publication may be reproduced by any means without the prior permission of Cowie Technology Group Ltd.



COWIE® Containers are manufactured using pure, virgin material which conforms to FDA and USP Class VI requirements.

- **Chemically inert**
- **Non-contaminating**
- **Thermally stable, -200°C to +280°C**
- **Super smooth finish**

We manufacture custom designed PTFE containers for specialist applications including:

- **Semi-Conductors**
- **Low temperature storage**
- **Archiving**
- **High performance packaging**
- **Combinatorial chemistry**
- **Diamond processing**

Send us your enquiry for custom designed containers to your exact requirements.

BOTTLES

Bottles with leak free performance are suitable for low temperature applications. Isostatically moulded with smooth internal finish.

Do **not use when sealed** for Chemical Reactions or Digestions. Loosen lid when thermally sterilising.

Ref No.	ml	Ht (mm)	OD (mm)	Ø Mouth (mm)
015.001.2	1	27	x 16	x 10
.005.2	5	35	x 22	x 10
.010.2	10	50	x 26	x 12
.025.2	25	61	x 33	x 19
.050.2	50	76	x 43	x 25
.100.2	100	88	x 52	x 35
.150.2	150	90	x 60	x 35
.250.2	250	115	x 67	x 42
.500.2	500	150	x 80	x 52
.1000.2	1000	185	x 100	x 57
.2000.2	2000	240	x 120	x 60
.5000.2	5000	335	x 170	x 80



JARS

Jars are isostatically moulded with thick wall construction, smooth internal finish and screw cap. 2.2L jar can be used for EPA Method 1311 TCLP.

Ref No.	ml	Fl oz	Ht (mm)	Cap Ø (mm)
038.015	15	0.5	34	x 36
.030	30	1	62	x 36
.060	60	2	46	x 60
.120	120	4	62	x 72
.240	240	8	100	x 72
.360	360	12	95	x 90
.480	480	16	125	x 90
.1000	1000	34	160	x 110
.2200	2200	120	Body Ø x 260	x 134



DROPPING BOTTLES & VIALS

Dropping Bottles are inert, leak free and flexible with a removable cap.

DROPPING BOTTLES

Ref No.	ml	Ht (mm)	OD (mm)
014.025	25	80	x 33
.050	50	100	x 43

Vials are for storage and shipping of valuable or aggressive materials and for small scale reactions at low pressure. Use to a maximum of 8psi at room temperature. Thick walled construction with tapered inner for ease of removal of contents.

VIALS

Ref No.	ml	Ht (mm)	OD (mm)
014.125	25	64	x 33
.150	50	78	x 43



PTFE used in the manufacture of COWIE® PTFE Laboratory Products is pure, virgin material which conforms to FDA and USP Class VI requirements.

BEAKERS



Beakers are isostatically moulded with super smooth internal finish and pouring spout.

Base is machined flat for good heat transfer.

Ref No.	ml	Ht	OD (mm)
007.001	1	18	x 13
.005	5	26	x 20
.010	10	33	x 24
.025	25	47	x 32
.050	50	55	x 43
.100	100	68	x 54
.150	150	75	x 59
.250	250	97	x 66
.400	400	106	x 80
.500	500	125	x 80
.600	600	125	x 90
.1000	1000	155	x 100
.2000	2000	205	x 125
.5000	5000	280	x 170

THERMOTECH™ BEAKERS



Thermotech™ Beakers feature a unique combination of a pure PTFE body with a specially formulated stabilised PTFE-Carbon base as a single moulding to give:

- **Totally inert pure PTFE inner surface**
- **Heatable to 280°C without distortion**
- **Improved heat transfer**

Ref No.	ml (Nom)	Ht (mm)	OD (mm) (Body)
007.0100	100	74	56
.0250	250	94	75
.0400	400	112	85

A COWIE® Registered Design

BEAKER COVERS



Beaker Covers are used for covering beakers during digestions and for spotting out.

Ref No.	Ø (mm)	Fits Beaker (ml)
013.020	20	1
.030	30	5-10
.040	40	25
.050	50	50
.065	65	100
.075	75	150
.080	80	250
.100	100	400-500
.125	125	600-1000
.150	150	2000
.200	200	5000

Dipper Beakers feature a basic container with a screw in PTFE encapsulated steel shaft. Additional shafts can be purchased separately to increase length. Shaft length 600mm.

Ref No.	ml	Fl oz	Body Ø (mm)
036.100	100	3	54
.250	250	8	66
.500	500	17	80
.1000	1000	34	100
036.001	Shaft only		

DIPPER BEAKERS



Ladle for sampling with fixed handle and pouring spouts on both sides of the container.

Ref No.	Capacity (ml)	Handle Length (mm)
037.010	10	150

LADLE



Crucibles have a super smooth internal finish, are chemically inert and usable to ca. 280°C.

Ref No.	ml	Ht	OD (mm)
009.005	5	16	x 27
.025	25	26	x 44
.075	75	41	x 56
.100	100	45	x 60

CRUCIBLES



PTFE used in the manufacture of COWIE® PTFE Laboratory Products is pure, virgin material which conforms to FDA and USP Class VI requirements.

EVAPORATING DISHES



Evaporating Dishes are inert and usable to ca. 280°C with a smooth internal finish.

FLAT FORM WITH SPOUT

Ref No.	ml	Ht	Ø (mm)
006.1025.1	25	12 x	65
.1050.1	50	15 x	82
.1100.1	100	20 x	102
.1180.1	180	22 x	130
.1350.1	350	36 x	132
.1400.1	400	40 x	136

FLAT FORM

Ref No.	ml	Ht	Ø (mm)
006.1025	25	25 x	42
.1050	50	20 x	60
.1100	100	28 x	80
.1180	180	46 x	80
.1350	350	55 x	100

TALL FORM WITH SPOUT

Ref No.	ml	Ht	Ø (mm)
006.025	25	34 x	38
.050	50	40 x	50
.100	100	50 x	64
.150	150	43 x	78
.180	180	50 x	80
.250	250	50 x	97
.350	350	60 x	100

ROUND BOTTOM FLASKS



Round Bottom Flasks have a smooth internal finish, are inert and usable to 280°C. Tapers match standard ground glass joints. Without sealing rings. Other sizes on request.

FULL LENGTH 'A' TYPE

Ref No.	ml	Joint	Ø (mm)
040.0010.19	10	19/38	32
.0025.24	25	24/40	42
.0050.24	50	24/40	52
.0050.29	50	29/42	52
.0100.29	100	29/42	64

MEDIUM LENGTH 'B' TYPE

Ref No.	ml	Joint	Ø (mm)
040.010.14	10	14/23	32
.010.19	10	19/26	32
.025.19	25	19/26	42
.025.24	25	24/29	42
.050.24	50	24/29	52
.050.29	50	29/32	52
.100.29	100	29/32	64

PTFE used in the manufacture of COWIE® PTFE Laboratory Products is pure, virgin material which conforms to FDA and USP Class VI requirements.

CENTRIFUGE-TEST TUBES

Test Tubes have a smooth internal finish and are usable to 280°C. Available with or without screw caps.

ROUND BOTTOM WITH SCREW CAP

Ref No.	ml	Ht	OD (mm)	Wall (mm)
012.1108	8	100	x 12	1.0
.1118	17	100	x 18	1.5
.1150	50	140	x 25	2.0

ROUND BOTTOM WITH LIP

Ref No.	ml	Ht	OD (mm)	Wall (mm)
012.108	8	100	x 12	1.0
.113	13	100	x 16	1.5
.118	17	100	x 18	1.5
.150	50	145	x 25	2.0
.180	85	100	x 40	3.0

CONICAL BOTTOM WITH SCREW CAP

Ref No.	ml	Ht	OD (mm)	Wall (mm)
012.1213	13	110	x 16	1.5
.1215	18	120	x 18	1.5
.1245	45	150	x 25	2.0

CONICAL BOTTOM WITH LIP

Ref No.	ml	Ht	OD (mm)	Wall (mm)
012.213	13	110	x 16	1.5
.215	18	120	x 18	1.5
.245	45	150	x 25	1.5



Test Tube Racks are totally inert.
Standard footprint 180 x 60 mm.
To fit tube sizes 8, 13, 19 & 30mm diameter.

Ref No.	Holes	Hole Ø (mm)	Ht (mm)
029.008	27	8	45
.013	21	13	60
.019	10	19	70
.030	4	30	80

TEST TUBE RACKS

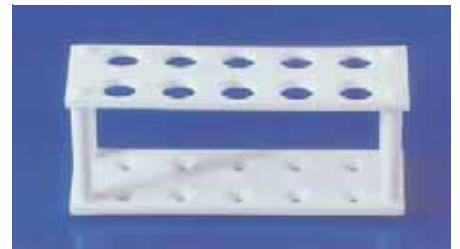

CUSTOM MANUFACTURE

We manufacture custom containers ranging from a simple item to your specification through to original design, development and validation.

Typical custom containers: test tubes, bottles, low temperature storage vessels and micro titre plates.

To receive our offer for custom containers please send your specification, including quantities required to -

enquiries@cowie.com.





We manufacture a wide range of standard PTFE jointware to facilitate and improve the use of standard taper ground glass jointware.

PTFE used in the manufacture of COWIE® Jointware is pure, virgin material which conforms to FDA and USP Class VI requirements.

- **Chemically inert**
- **Prevent sticking**
- **Grease free**
- **Eliminate contamination**
- **High vacuum**
- **Safety**

Send us your enquiry for custom designed jointware to meet your exact requirements.

JOINT CLAMPS

Safe • Reliable • Long Life • Exceptional Value

Joint Clamps are unaffected by all chemical reagents. Totally encapsulated steel spring maintains strength to 280°C. Adjust simply by compression-extension by hand.

Ref No.	Joint
030.010.1	10/-
.012.1	12/-
.014.1	14/-
.019.1	19/-
.024.1	24/-
.029.1	29/-
.034.1	34/-
.040.1	40/-
.045.1	45/-



A COWIE® Original Design

THIN WALL JOINT SLEEVES

Thin Wall Joint Sleeves are inserted between standard taper ground glass joints to eliminate the use of grease and prevent sticking. Sleeves have a wall thickness of about 0.05mm and will withstand low to medium vacuum.

FULL LENGTH 'A' TYPE

Ref No.	Joint
019.007	7/25
.010	10/30
.012	12/30
.014.1	14/20
.014	14/35
.019.1	19/22
.019	19/38
.024	24/40
.029	29/42
.034	34/45
.040	40/50
.045	45/50
.050	50/50
.055	55/50
.060	60/50
.070	71/60

MEDIUM LENGTH 'B' TYPE

Ref No.	Joint
019.107	7/16
.110	10/19
.112	12/21
.114	14/23
.119	19/26
.124	24/29
.129	29/32
.134	34/35
.140	40/38
.145	45/40
.150	50/42
.155	55/44
.160	60/46
.170	71/51



RIGID JOINT SLEEVES



A COWIE® Original Patent

Rigid Sleeves and Joint Adapters are grease-free, high vacuum seals for standard taper ground glass joints, with substantial shoulder for ease of handling and repeated use. High vacuum performance (leakage rate is less than 1×10^{-4} torr, litre, sec.⁻¹) is attained using transverse sealing rings. Wall thickness of rigid sleeves is 0.5 mm.

FULL LENGTH 'A' TYPE

Ref No.	Joint
020.110	10/30
.114.1	14/20
.119.1	19/22
.124	24/40
.129	29/42
.134	34/45
.145	45/50
.155	55/50

MEDIUM LENGTH 'B' TYPE

Ref No.	Joint
020.010	10/19
.014	14/23
.019	19/26
.024	24/29
.029	29/32
.034	34/35
.040	40/38
.045	45/40
.055	55/44

JOINT ADAPTERS



FULL LENGTH 'A' TYPE

Ref No.	Socket	Cone
021.01014	10/30	14/35
.01019	10/30	19/38
.01419	14/35	19/38
.01424	14/35	24/40
.01924	19/38	24/40
.01929	19/38	29/42
.01934	19/38	34/45
.02429	24/40	29/42
.02434	24/40	34/45
.02445	24/40	45/50
.02934	29/42	34/45
.02945	29/42	45/50
.03445	34/45	45/50

MEDIUM LENGTH 'B' TYPE

Ref No.	Socket	Cone
021.1014	10/19	14/23
.1019	10/19	19/26
.1419	14/23	19/26
.1424	14/23	24/29
.1924	19/26	24/29
.1929	19/26	29/32
.1934	19/26	34/35
.2429	24/29	29/32
.2434	24/29	34/35
.2445	24/29	45/40
.2934	29/32	34/35
.2945	29/32	45/40
.3445	34/35	45/40

STANDARD TAPER COMPRESSION FITTINGS

Compression Fittings fit standard taper ground glass joints to hold items such as temperature probes and sampling tubes securely in place.

Compression fittings are manufactured from pure PTFE with a PEEK olive to give a secure grip.

PTFE Plugs are available to seal compression fittings without removing the fitting - see page 51 for sizes.

To define the Reference Number of the required part add the bore size suffix to the required taper reference using the table below.

Example:

A fitting with a 19/38 taper and 8mm bore is -
PC704.1938.08



FULL LENGTH 'A' TYPE - METRIC BORE

Ref No.	Taper	Bore Size (mm)							
		3	6	8	12	14	16	19	25
PC704.1938.XX	19/38	.03	.06	.08	.12				
.2440.XX	24/40		.06	.08	.12	.14	.16		
.2942.XX	29/42				.12	.14	.16	.19	
.3445.XX	34/45				.12	.14	.16	.19	.25
.4550.XX	45/50				.12	.14	.16	.19	.25

MEDIUM LENGTH 'B' TYPE - METRIC BORE

Ref No.	Taper	Bore Size (mm)							
		3	6	8	12	14	16	19	25
PC704.1926.XX	19/26	.03	.06	.08	.12				
.2429.XX	24/29		.06	.08	.12	.14	.16		
.2932.XX	29/32				.12	.14	.16	.19	
.3435.XX	34/35				.12	.14	.16	.19	.25
.4540.XX	45/40				.12	.14	.16	.19	.25

FULL LENGTH 'A' TYPE - IMPERIAL BORE

Ref No.	Taper	Bore Size (in)							
		1/8"	1/4"	5/16"	1/2"	9/16"	5/8"	3/4"	1"
PC704.1938.XXX	19/38	.125	.250	.312	.500				
.2440.XXX	24/40		.250	.312	.500	.560	.625		
.2942.XXX	29/42				.500	.560	.625	.750	
.3445.XXX	34/45				.500	.560	.625	.750	.1000
.4550.XXX	45/50				.500	.560	.625	.750	.1000

MEDIUM LENGTH 'B' TYPE - IMPERIAL BORE

Ref No.	Taper	Bore Size (in)							
		1/8"	1/4"	5/16"	1/2"	9/16"	5/8"	3/4"	1"
PC704.1926.XXX	19/38	.125	.250	.312	.500				
.2429.XXX	24/40		.250	.312	.500	.560	.625		
.2932.XXX	29/42				.500	.560	.625	.750	
.3435.XXX	34/45				.500	.560	.625	.750	.1000
.4540.XXX	45/50				.500	.560	.625	.750	.1000

PTFE used in the manufacture of COWIE® PTFE Laboratory Products is pure, virgin material which conforms to FDA and USP Class VI requirements.

FLAT HEAD STOPPERS



Flat Head Stoppers fit standard taper ground glass joints. Trapezoidal rings give high vacuum performance and reduce seizure.

FULL LENGTH 'A' TYPE

Ref No.	Joint	Ht (mm)
010.110	10/30	40
.114	14/35	46
.119	19/38	50
.124	24/40	55
.129	29/42	57
.134	34/45	60

MEDIUM LENGTH 'B' TYPE

Ref No.	Joint	Ht (mm)
010.210	10/19	31
.214	14/23	34
.219	19/26	38
.224	24/29	44
.229	29/32	47
.234	34/35	51

SELF RELEASING STOPPERS



Self Releasing Stoppers fit standard taper ground glass joints, with sealing rings and self releasing ring for ease of removal.

FULL LENGTH 'A' TYPE

Ref No.	Joint	Ht (mm)
010.1119	19/38	62
.1124	24/40	65
.1134	34/45	70
.1145	45/50	75

MEDIUM LENGTH 'B' TYPE

Ref No.	Joint	Ht (mm)
010.1219	19/26	50
.1224	24/29	55
.1229	29/32	60
.1234	34/35	62
.1245	45/40	65

PENNY HEAD STOPPERS



PTFE Penny Head Stoppers are hollow, for standard taper joints. No sealing rings.

Ref No.	Size (US)
010.3.09	9
.3.13	13
.3.16	16
.3.19	19
.3.22	22
.3.27	27
.3.32	32

Flexible bellow connectors are machined from pure PTFE and used to correct mis-alignment and relieve stress in glassware assemblies. Connect directly to standard taper ground glass joints where trapezoidal sealing rings give medium to high vacuum performance. Inert and usable to ca. 280°C.

FULL LENGTH 'A' TYPE

Ref No.	Socket	Cone	Ht (mm)
008.1414	14/35	14/35	115
.1919.1	19/22	19/22	90
.1919	19/38	19/38	120
.2424	24/40	24/40	130
.2929	29/42	29/42	140
.3434	34/45	34/45	145
.4545	45/50	45/50	155

MEDIUM LENGTH 'B' TYPE

Ref No.	Socket	Cone	Ht (mm)
008.01414	14/23	14/23	90
.01429	14/23	29/32	110
.01919	19/26	19/26	100
.01924	19/26	24/29	105
.02424	24/29	24/29	110
.02929	29/32	29/32	115
.02934	29/32	34/35	120
.03434	34/35	34/35	120

FLEXIBLE BELLOWS



Round Bottom Flasks have a smooth internal finish, are inert and usable to 280°C. Tapers match standard ground glass joints. Without sealing rings. Other sizes on request.

FULL LENGTH 'A' TYPE

Ref No.	ml	Joint	Ø (mm)
040.0010.19	10	19/38	32
.0025.24	25	24/40	42
.0050.24	50	24/40	52
.0050.29	50	29/42	52
.0100.29	100	29/42	64

MEDIUM LENGTH 'B' TYPE

Ref No.	ml	Joint	Ø (mm)
040.010.14	10	14/23	32
.010.19	10	19/26	32
.025.19	25	19/26	42
.025.24	25	24/29	42
.050.24	50	24/29	52
.050.29	50	29/32	52
.100.29	100	29/32	64

ROUND BOTTOM FLASKS



Please ask for alternative sizes
or customised jointware.



A full range of PTFE Valves, Connectors and Stopcocks for Burettes and general laboratory use.

PTFE used in the manufacture of COWIE® PTFE Laboratory Products is pure, virgin material which conforms to FDA and USP Class VI requirements.

- **Chemically inert**
- **Grease free**
- **Eliminates contamination**
- **Medium vacuum/Pressure performance**

We custom manufacture all types of valves, connectors and stopcocks to customers specification.

Please send us your enquiry.

BAYONET FITTING SYSTEMS - CONNECTORS

FOR FLEXIBLE TUBING

Connectors with bayonet fittings are for use with flexible tubing in PTFE, VITON, silicone rubber or similar materials. The connectors are pure PTFE and may be sterilised at 135°C.

PTFE TUBING

Ref No.	OD (mm)	Wall (mm)
016.1706	6	1
.1708	8	1
.1712	12	1
.1714	14	1



STRAIGHT THROUGH CONNECTOR

Ref No.	Arm Ø (mm)	Bore (mm)
016.902.5.2	4.5	2
.902.2	6.0	2
.903.7.2	6.8	3
.903.2	8.0	3
.904.9.2	9.0	4
.904.2	10.0	4
.905.2	11.0	5



RIGHT ANGLE CONNECTOR

Ref No.	Arm Ø (mm)	Bore (mm)
016.1002.5.2	4.5	2
.1002.2	6.0	2
.1003.7.2	6.8	3
.1003.2	8.0	3
.1004.9.2	9.0	4
.1004.2	10.0	4
.1005.2	11.0	5



T-TYPE CONNECTOR

Ref No.	Arm Ø (mm)	Bore (mm)
016.1102.5.2	4.5	2
.1102.2	6.0	2
.1103.7.2	6.8	3
.1103.2	8.0	3
.1104.9.2	9.0	4
.1104.2	10.0	4
.1105.2	11.0	5



4-WAY CONNECTOR

Ref No.	Arm Ø (mm)	Bore (mm)
016.1112.5.2	4.5	2
.1112.2	6.0	2
.1113.7.2	6.8	3
.1113.2	8.0	3
.1114.9.2	9.0	4
.1114.2	10.0	4
.1115.2	11.0	5



GENERAL PURPOSE VALVES

A range of plug valves for use with our connectors for less demanding pressure and temperature applications:

Max pressure 1 bar

Vacuum 5 mmHg

Note: Rapid changes in temperature over a range of 25°C may cause these valves to leak due to the expansion properties of PTFE. Can be sterilised at 135°C.

STRAIGHT THROUGH BAYONET



Ref No.	Arm Ø (mm)	Bore (mm)
016.702.5.2	4.5	2
.702.2	6	2
.703.7.2	6.8	3
.703.2	8	3
.704.9.2	9	4
.704.2	10	4
.705.2	11	5

STRAIGHT THROUGH SCREW



Ref No.	Tube OD (mm)	Bore (mm)
016.1202.6.2	6	2
.1203.2	8	3
.1204.2	8	4

T-TYPE BAYONET



Ref No.	Arm Ø (mm)	Bore (mm)
016.802.5.2	4.5	2
.802.2	6	2
.803.7.2	6.8	3
.803.2	8	3
.804.9.2	9	4
.804.2	10	4
.805.2	11	5

T-TYPE SCREW



Ref No.	Tube OD (mm)	Bore (mm)
016.1302.6.2	6	2
.1303.2	8	3
.1304.2	8	4

CUSTOM PTFE JOINTWARE

We manufacture jointware to all specifications. Send us a sample or drawing of your requirements.

STOPCOCKS

Stopcocks feature a pure PTFE body and plug and combine all the desirable properties of the **Ultimate Laboratory Stopcock**; Medium vacuum pressure performance, unbreakable, inert and grease free.

Plug cannot be accidentally withdrawn and have easily connected sidearms in glass or PTFE to give inert vacuum and pressure tight seals. Stopcocks for use with burettes have glass or unbreakable polypropylene tips.

Buret Stopcock supplied with Ø8mm sidearm in borosilicate glass, bore is 2mm. Push-lock tip is polypropylene or glass.

STRAIGHT THROUGH TYPE

Ref No.	
016.9202-B	Polypropylene Tip
.9203-B	Glass Tip

REPLACEMENT TIP

Ref No.	
016.9202.1	Polypropylene
016.9212.1	Glass



BURETTE STOPCOCK



STRAIGHT THROUGH STOPCOCK



Supplied with borosilicate glass sidearms.

Ref No.	Bore (mm)	Arm Ø (mm)
016.002	2	x 8
.003	3	x 8
.004	4	x 10
.006	6	x 14
.008	8	x 14
.010	10	x 14

Supplied with borosilicate glass side arms.

Ref No.	Bore (mm)	Arm Ø (mm)
016.102	2	x 8
.103	3	x 8
.104	4	x 10

T-TYPE STOPCOCK



CUSTOM PTFE STOPCOCK PLUGS

We manufacture stopcock keys to all specifications. Send us a sample or drawing of your requirements

RIGID TWEEZERS

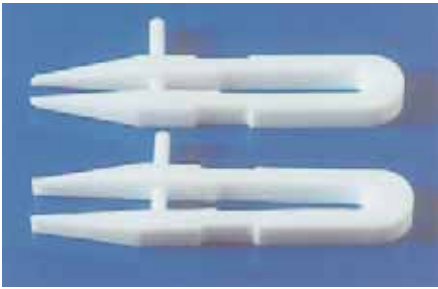

Tweezers are inert and non-contaminating.

SHARP END

Ref No.	Length (mm)
027.101	100
.151	150
.201	200

SQUARE END

Ref No.	Length (mm)
027.100	100
.150	150
.200	200

FINE TWEEZERS

**SHARP END**

Ref No.	Length (mm)
027.0101	100
.0151	150
.0201	200

SQUARE END

Ref No.	Length (mm)
027.0100	100
.0150	150
.0200	200

SPATULAS



Spatulas are 5mm thick.

Ref No.	L (mm)		W (mm)
043.120	120	x	12
.150	150	x	18
.180	180	x	20
.210	210	x	25
.240	240	x	30

FUNNELS



Funnels are chemically inert with super smooth non-stick internal finish.

Ref No.	Ø (mm)	Ø Stem (mm)	Ht (mm)
039.030	30	8	50
.050	50	10	85
.070	70	12	110
.100	100	14	170
.150	150	16	220

SCOOP



Scoops are chemically inert and non-contaminating. Overall Length 140mm.

Ref No.	Scoop D (mm)	W (mm)	L (mm)
041.001	20	30	80

BOTTLE POURER

Bottle Pourer permits direct pouring of all liquids from reagent bottles in a safe and consistent manner.

Totally inert with PTFE encapsulated viton neck seal.

To fit GL30, 32, 38 and 45 screw neck bottles.

Ref No.	Fits Neck
028.030	GL30
.032	GL32
.038	GL38
.045	GL45

**TISSUE GRINDERS/HOMOGENISERS**

Tissue grinders are used for the controlled reduction of particle size and homogenisation of a variety of substances, especially biological material. Size reduction/homogenisation is brought about by the shearing forces generated by the movement of a rotating plunger in a precision bore tube. Determining factors include clearance between plunger head and tube, speed of rotation and viscosity of medium.

The plunger head is pure PTFE and the plunger shaft stainless steel, Ø6.5mm. The tube is precision borosilicate glass and the clearance between the plunger head and tube 0.15-0.25mm. Other clearances are readily available. Volumes stated are working volumes with the plunger in place.

GLASS VESSEL

Ref No.	ml	Bore (mm)	Ht (mm)
011.102	2	8	120
.105	5	12	135
.110	10	15	150
.115	15	19	155
.130	30	25	175
.150	50	32	195

PLUNGER - PLAIN

Ref No.	ml	Ht (mm)
011.202	2	230
.205	5	235
.210	10	270
.215	15	270
.230	30	270
.250	50	270

PLUNGER - SERRATED TIP

Ref No.	ml	Ht (mm)
011.302	2	230
.305	5	235
.310	10	270
.315	15	270
.330	30	270
.350	50	270



The worlds largest range of stirrer bars -



- Isostatic encapsulation to eliminate cracks and porosity
- FDA and USP Class VI approved PTFE
- Alnico V and Rare Earth magnet cores
- Polished finish to reduce pick-up and cross contamination

Magnetic stirring is a widely used and long established method for stirring and mixing in liquid media. The process is not only simple and inexpensive, but extremely diverse in the range of application.

Examples include: synthetic procedures, drug delivery, chemical analysis, flow control, emulsification, milling and grinding and solid phase extraction.

Magnetic stirring can be used in open and closed systems, over a range of positive and negative pressure, over a broad temperature range and with virtually any chemical reagent. The use of bearings, glands, seals and complex drive mechanisms common to other mixing systems are not required.

Magnetic stirring - Key Points

Material:

PTFE is the material of choice for encapsulation because of its almost total chemical resistance and its wide range of working temperature -200°C to $+280^{\circ}\text{C}$.

Shape:

It is difficult to quantify the most effective shape for a particular stirring application, some shapes are self-evident, for example, an oval or egg shape for round bottom containers or a flat and triangular shape where a scraping action is required, large containers generally require large stirring bars. For very viscous liquids a vaned stirrer at slow speed is required, while for stirring in shallow dishes a long thin stirrer also at slow speed is effective. Often, however, selection is a matter of choice or trial with various shapes.

Particle Formation and Abrasion:

PTFE is a relatively soft material and the rubbing action against the surface of the container may generate small particles. In an application where the generation of such particles must be avoided, the stirring system must be evaluated before actual use. Generation of particles is reduced by careful selection of the shape of stirrer, ensuring the contact surfaces are smooth and even, not using an over powerful stirring bar or use suspended stirring.

Coupling Effects:

De-coupling in the form of spin-out, tumbling or migration is generally due to weakness in the strength of the magnetic circuit, a mismatch in the sizes of drive magnet and stirrer bar or a stirring speed too high.

Rare Earth Magnets:

Rare Earth Magnets may behave in an erratic manner due to increased strength and may migrate to one of the poles of the drive magnet or tumble with great ease and must, therefore, be selected with great care. Due to the strength of Rare Earth Magnets, there may be an increase in abrasion between the container and stirrer, which may cause increased particle generation.

Sterilisation:

PTFE stirring bars can be sterilised by chemical or thermal means, but not by gamma radiation.

Traceability & Change Control:

Full traceability and change control agreements available on request.

CYLINDRICAL

Cylindrical Stirrer Bars have a smooth, round profile. A popular general purpose stirrer for a wide variety of applications.

Ref No.	L (mm)	Ø (mm)
001.106	6 x	3
.108	8 x	3
.110.6	10 x	6
.112	12 x	4.5
.113.6	13 x	6
.113.8	13 x	8
.113.10	13 x	10
.115	15 x	4.5
.115.6	15 x	6
.120	20 x	6
.120.7	20 x	7
.120.8	20 x	8
.125.5	25 x	5
.125	25 x	6
.125.8	25 x	8
.130	30 x	6
.130.7	30 x	7
.130.8	30 x	8
.135	35 x	6
.140.7	40 x	7
.140	40 x	8
.145	45 x	8
.150	50 x	8
.160	60 x	10
.170	70 x	10
.180	80 x	10
.0120	120 x	12
.0127	127 x	12
.0165	165 x	12



PLAIN

Plain Stirrer Bars have a similar action to cylindrical but give more turbulence at low speed.

Ref No.	L (mm)	Ø (mm)
001.210.6	10 x	6
.212	12 x	4.5
.213.8	13 x	8
.215	15 x	4.5
.215.6	15 x	6
.220	20 x	6
.220.7	20 x	7
.225	25 x	6
.225.8	25 x	8
.225.10	25 x	10
.230	30 x	6
.230.7	30 x	7
.235	35 x	6
.235.7	35 x	7
.235.10	35 x	10
.240	40 x	8
.250.7	50 x	7
.250	50 x	8
.250.10	50 x	10
.257	57 x	27
.260.7	60 x	7
.260.8	60 x	8
.260	60 x	10
.265.13	65 x	13
.270	70 x	10
.275	75 x	13
.280	80 x	10
.2108	108 x	27
.2159	159 x	27



PTFE Stirrer Bar dimensions are NOMINAL and are approximately $\pm 5\%$ for Length and $\pm 10\%$ for Diameter of the stated values.

PIVOT RING



Pivot Ring Stirrer Bars are for use in containers with bases that are slightly curved or uneven - the pivot enables the stirrer to adopt the optimum position for stirring.

Ref No.	L (mm)	Ø (mm)
001.308	8 x 3	
.312	12 x 4.5	
.312.6	12 x 6	
.313.8	13 x 8	
.315	15 x 4.5	
.315.8	15 x 8	
.320	20 x 6	
.325	25 x 6	
.325.10	25 x 10	
.330	30 x 6	
.335	35 x 6	
.340	40 x 8	
.345	45 x 8	
.350	50 x 8	
.357	57 x 24	
.360	60 x 10	
.370	70 x 10	
.375.13	75 x 13	
.3108	108 x 24	
.3159	159 x 24	

OCTAHEDRAL



Octahedral Stirrer Bars use a similar action to Pivot Ring type but with increased turbulence at low speeds.

Ref No.	L (in)	Ø (in)	L (mm)	Ø (mm)
001.513.3	½ x ⅙		13 x 3	
.513	½ x ⅙		13 x 8	
.513.10	½ x ⅙		13 x 10	
.515	⅝ x ⅙		15 x 8	
.522	⅞ x ⅙		22 x 8	
.525	1 x ⅙		25 x 8	
.525.10	1 x ⅙		25 x 10	
.528	1¼ x ⅙		28 x 8	
.538	1½ x ⅙		38 x 8	
.538.10	1½ x ⅙		38 x 10	
.541	1¾ x ⅙		41 x 8	
.551	2 x ⅙		51 x 8	
.551.10	2 x ⅙		51 x 10	
.564.8	2½ x ⅙		64 x 8	
.564	2½ x ⅙		64 x 10	
.575	3 x ½		75 x 13	

COLOURED OCTAHEDRAL



Coloured Octahedral Stirrer Bars are for use where identification is of prime importance.

Note: Coloured PTFE coatings are not as inert as pure PTFE. Suffix R=Red, B=Blue, Y=Yellow

Ref No.	L (in)	Ø (in)	L (mm)	Ø (mm)
001.513-R,B or Y	½ x ⅙		13 x 8	
.515-R,B or Y	⅝ x ⅙		15 x 8	
.522-R,B or Y	⅞ x ⅙		22 x 8	
.525-R,B or Y	1 x ⅙		25 x 8	
.538-R,B or Y	1½ x ⅙		38 x 8	
.551-R,B or Y	2 x ⅙		51 x 8	
.575-R,B or Y	3 x ½		75 x 13	

MICRO

Micro Stirrer Bars are for the very smallest containers.
Note: Always use the largest stirrer bar possible.

Ref No.	L (mm)	Ø (mm)
001.802	2 x 2	
.803	3 x 3	
.805	5 x 2	
.806	6 x 3	
.807	7 x 2	
.808	8 x 1.5	
.808.3	8 x 3	
.810	10 x 3	
.813	13 x 3	
.815	15 x 1.5	
.820	20 x 3	
.830	30 x 3	



COLOURED MICRO

Coloured Micro Stirrer Bars for identification purposes.
Note: Coloured PTFE coatings are not as inert as pure PTFE. Suffix R=Red, B=Blue, Y=Yellow

Ref No.	L (mm)	Ø (mm)
001.802-R,B or Y	2 x 2	
.803-R,B or Y	3 x 3	
.805-R,B or Y	5 x 2	
.806-R,B or Y	6 x 3	
.807-R,B or Y	7 x 2	
.808-R,B or Y	8 x 1.5	
.808.3-R,B or Y	8 x 3	
.810-R,B or Y	10 x 3	
.813-R,B or Y	13 x 3	
.815-R,B or Y	15 x 1.5	



OVAL

Oval Stirrer Bars are for use in round bottomed flasks.

Ref No.	L (mm)	Ø (mm)
001.610	10 x 5	
.615	15 x 6	
.620	20 x 10	
.625.10	25 x 10	
.625	25 x 12	
.630.10	30 x 10	
.630	30 x 16	
.635.13	35 x 13	
.635	35 x 16	
.640.13	40 x 13	
.640	40 x 20	
.650.17	50 x 17	
.650	50 x 20	
.664	64 x 20	
.670	70 x 20	
.670.25	70 x 25	
.670.27	70 x 27	
.6100	100 x 30	
.6150	150 x 40	



OCTOVAL

Octoval Stirrer Bars are an effective stirrer with action similar to Oval/Pivot Ring types.

Ref No.	L (mm)	Ø (mm)	L (mm)	Ø (in)
001.3319	19	x 10	¾	x ⅜
.3325	25	x 13	1	x ½
.3338	38	x 16	1½	x ⅝
.3341	41	x 19	1⅝	x ¾
.3351	51	x 19	2	x ¾
.3364	64	x 19	2½	x ¾
.3376	76	x 19	3	x ¾



REMOVABLE RING



Removable Ring Stirrer Bars are for use as Cylindrical or Pivot Ring types.

Ref No.	L (mm)	Ø (mm)
001.1712	12 x	8
.1725	25 x	8
.1732	32 x	8
.1738.8	38 x	8
.1738	38 x	10
.1742	42 x	10
.1751.8	51 x	8
.1751	51 x	10
.1775	75 x	12
.17102	102 x	16
.17127	127 x	16
.17150	150 x	19

TAPERED



Tapered Stirrer Bars are an effective stirrer with action similar to Oval/Pivot Ring types.

Ref No.	L (mm)	Ø (mm)
001.1910	10 x	4
.1915	15 x	5
.1920	20 x	7
.1925	25 x	8
.1930	30 x	8
.1935	35 x	8
.1940	40 x	8
.1945	45 x	8
.1950	50 x	8
.1955	55 x	8
.1960	60 x	8
.1970	70 x	10
.1980	80 x	10

DOUBLE ENDED



Double Ended Stirrer Bars have a double paddle action for efficient stirring plus high stability.

Note: Coloured PTFE coatings are not as inert as pure PTFE.

NATURAL

Ref No.	L (mm)	Ø (mm)
001.1335	35 x	8
.1355	55 x	8

COLOURED

Suffix R=Red, B=Blue, Y=Yellow

Ref No.	L (mm)	Ø (mm)
001.1335-R,B or Y	35 x	8
.1355-R,B or Y	55 x	8

PTFE used in the manufacture of COWIE® PTFE Laboratory Products is pure, virgin material which conforms to FDA and USP Class VI requirements.

Triangular Stirrer Bars are effective for dissolving solids and mixing sediments because of the scraper-like action.

Ref No.	L (mm)	Ø (mm)
001.412	12 x	6
.420	20 x	8
.425	25 x	8
.425.14	25 x	14
.435	35 x	9
.440	40 x	14
.450	50 x	12
.455	55 x	14
.480	80 x	14
.4110	110 x	36
.4136	136 x	36



TRIANGULAR

Triangle with Rib Stirrer Bars have excellent turbulence at all speeds and can be used on uneven surfaces.

Ref No.	L (mm)	Ø (mm)
001.1812	12 x	6
.1825	25 x	8
.1835	35 x	9
.1850	50 x	12
.1880	80 x	18



TRIANGLE WITH RIB

Wing Stirrer Bars for effective stirring in small tapered and round bottom test, centrifuge and sample tubes.

Ref No.	Ht (mm)	Ø (mm)	Tube ID (mm)
001.2201.1	9 x	5.5	6 - 7
.2201	11 x	8	9 - 10
.2202	16 x	10	11 - 12
.2203	10 x	13	14 - 15
.2204	20 x	13	14 - 15



WING

Giant Stirrer Bars are for use in very large containers.

CYLINDRICAL

Ref No.	L (mm)	Ø (mm)
001.0120	120 x	12
.0127	127 x	12
.0165	165 x	12

PLAIN

Ref No.	L (mm)	Ø (mm)
001.257	57 x	27
.2108	108 x	27
.2159	159 x	27

PIVOT RING

Ref No.	L (mm)	Ø (mm)
001.357	57 x	24
.3108	108 x	24
.3159	159 x	24

TRIANGLE

Ref No.	L (mm)	Ø (mm)
001.480	80 x	14
.4110	110 x	36
.4136	136 x	36



GIANT

PTFE Retrievers for use with Giant Stirrer Bars - see page 32

CROSS

Cross Stirrer Bars are very stable general purpose stirrers.

Ref No.	Ø (in)	Ø (mm)	Ht (mm)
001.2401	$\frac{3}{8}$ "	10	5
.2402	$\frac{3}{4}$ "	20	8
.2403	1"	25	9
.2404	1 $\frac{1}{4}$ "	30	10
.2405	1 $\frac{1}{2}$ "	38	11
.2406	2"	50	15
.2407	2 $\frac{3}{8}$ "	60	20

CROSSHEAD

Crosshead Stirrer Bars are designed for use with tube-like containers yet very effective as general stirrers.

DOUBLE SIDED

Ref No.	Ht (mm)	Ø (mm)
001.1110	8 x	10
.1114	10 x	14
.1117	13 x	17
.1122	15 x	22
.1130	12 x	30
.1135	12 x	35
.1140	14 x	40
.1160	15 x	60

SINGLE SIDED

Ref No.	Ht (mm)	Ø (mm)
001.1110.1	8 x	10
.1114.1	12 x	14
.1117.1	13 x	17
.1125.1	15 x	25
.1140.1	17 x	40
.1160.1	17 x	60

HUB

Hub Stirrer Bars are very stable stirrers, especially at low speeds.

Ref No.	L (mm)	Ø (mm)
001.2301	45 x	27
.2302	62 x	37
.2303	70 x	37

TUBE

Tube Stirrer Bars are designed for use with 10mm standard cuvettes.

Ref No.	Ht (mm)	Ø (mm)
001.1609	6 x	9

Disc Stirrer Bars are for use in tubes.

Ref No.	Ht (mm)	Ø (mm)
001.709	6 x	9
.710	6 x	10
.720	10 x	20
.730	12 x	30

Square Economy Stirrer Bars give a highly effective mixing over a wide range of conditions and offer outstanding value.

Ref No.	L (mm)	Ht (mm)
001.1412	12 x	4
.1425	25 x	5.5
.1435	35 x	6
.1450	50 x	7.5

Plain Economy Stirrer Bars give a highly effective mixing over a wide range of conditions and offer outstanding value.

Ref No.	L (mm)	Ø (mm)	L (in)	Ø (in)
001.2912	12 x	3	½ x	⅙
.2925	25 x	8	1 x	⅝
.2940	40 x	8	1½ x	⅝
.2950	50 x	8	2 x	⅝

Spherical Stirrer Bars are of special interest for tubes and eccentric stirring.

Ref No.	Ø (mm)
001.1512	12

Ref No.	L (mm)	Ø (mm)
001.1206	6 x	5
.1212	12 x	5
.1219	19 x	6
.1225	25 x	6
.1245	45 x	8
.1250	50 x	8
.1260	60 x	8

PTFE used in the manufacture of COWIE® PTFE Laboratory Products is pure, virgin material which conforms to FDA and USP Class VI requirements.

DISC



SQUARE ECONOMY



PLAIN ECONOMY



SPHERICAL



GLASS COVERED



BOXED SETS

Boxed Sets include an assortment of useful sizes of each type of stirrer bar in a re-usable container.

CYLINDRICAL



Ref No.	No. of Bars	L (mm)	Ø (mm)	Qty
001.3003	18	10	x 6	2
		15	x 6	2
		20	x 7	2
		25	x 8	2
		30	x 8	2
		40	x 8	2
		50	x 8	2
		60	x 10	2
		80	x 10	2
001.3019	18	10	x 6	2
		15	x 4.5	2
		20	x 6	2
		25	x 6	2
		30	x 6	2
		40	x 8	2
		50	x 8	2
		60	x 10	2
		70	x 10	2

CYLINDRICAL & REMOVABLE RING



Ref No.	No. of Bars	L (mm)	Ø (mm)	Qty	
001.3020	6	13	x 10	2	
		(Cylindrical)	13	x 8	2
	16	(Rem. Ring)	20	x 8	2
			25	x 8	4
			32	x 8	2
			38	x 8	2
			38	x 10	1
			42	x 10	3
			51	x 10	2
			51	x 8	2

PLAIN



Ref No.	No. of Bars	L (mm)	Ø (mm)	Qty
001.3004	18	10	x 6	2
		15	x 6	2
		20	x 7	2
		25	x 8	2
		30	x 7	2
		40	x 8	2
		50	x 8	2
		60	x 7	2
		80	x 10	2

TAPERED & RETRIEVER



Ref No.	No. of Bars	L (mm)	Ø (mm)	Qty	
001.3033	20	10	x 4	2	
		(Tapered)	15	x 5	2
		20	x 7	2	
		25	x 8	2	
		30	x 8	2	
		35	x 8	2	
		40	x 8	2	
		50	x 8	2	
		60	x 8	2	
		70	x 10	1	
		80	x 10	1	
		1 (Retriever)	300	x 10	1

OCTAHEDRAL

Ref No.	No. of Bars	L (mm)	Ø (mm)	Qty
001.3001	12	13 x 8	2	
		15 x 8	2	
		25 x 10	2	
		38 x 10	2	
		51 x 10	2	
		64 x 10	2	



COLOURED OCTAHEDRAL

Ref No.	No. of Bars	L (mm)	Ø (mm)	Qty (1 each colour)
001.3017	24	13 x 3	3	
		13 x 8	3	
		15 x 8	3	
		22 x 8	3	
		25 x 8	3	
		38 x 8	3	
		51 x 8	3	
		75 x 13	3	



OCTAHEDRAL & MICRO

Ref No.	No. of Bars	L (mm)	Ø (mm)	Qty
001.3021	10 (Octahedral)	13 x 8	2	
		15 x 8	2	
		25 x 10	2	
		38 x 10	2	
		51 x 10	2	
4 (Micro)	4	7 x 2	2	
		10 x 3	2	



COLOURED MICRO

Ref No.	No. of Bars	L (mm)	Ø (mm)	Qty (1 each colour)
001.3006	12	8 x 1.5	3	
		5 x 2	3	
		7 x 2	3	
		10 x 3	3	



CROSS

Ref No.	No. of Bars	L (mm)	Ø (mm)	Qty
001.3032	5	10 x 10	1	
		20 x 20	1	
		25 x 25	1	
		30 x 30	1	
		38 x 38	1	



OVAL

Ref No.	No. of Bars	L (mm)	Ø (mm)	Qty
001.3002	12	10 x 5	2	
		15 x 6	2	
		25 x 10	2	
		30 x 10	2	
		35 x 13	2	
		50 x 17	1	
001.3015	13	70 x 27	1	
		20 x 10	2	
		25 x 12	2	
		30 x 16	2	
		35 x 16	2	
		40 x 20	2	
		50 x 20	2	
		70 x 20	1	



'TURBO' STIRRER BARS

Extra power Samarium-Cobalt magnets

Turbo Stirrer Bars use rare earth magnets to provide significantly increased magnetic strength compared to Alnico magnets and are almost **totally resistant to demagnetisation**. Turbo Stirrer Bars are identified by a **carbon black spot**, which is chemically inert.

Note on using Turbo Stirrer Bars:

The high magnetic coupling power of Rare Earth magnets used in Turbo Stirrer Bars can give rise to erratic stirring effects such as magnet migration and tumbling while the powerful attraction between the stirrer and the drive magnet system can give rise to the formation of PTFE particles caused by abrasion between stirrer magnet and the container base.

TURBO ELLIPTICAL



Ref No.	L (mm)	Ø (mm)
001.2610.RE	10 x	6
.2615.RE	15 x	10
.2625.RE	25 x	14
.2650.RE	50 x	24
.2670.RE	70 x	28

TURBO OVAL



Ref No.	L (mm)	Ø (mm)
001.610.RE	10 x	5
.615.RE	15 x	6
.620.RE	20 x	10
.625.RE	25 x	12
.635.RE	35 x	16
.640.RE	40 x	20
.650.RE	50 x	20
.664.RE	64 x	20

TURBO OCTAHEDRAL



Ref No.	L (mm)	Ø (mm)
001.513.3.RE	13 x	3
.513.RE	13 x	8
.515.RE	15 x	8
.525.RE	25 x	8
.538.RE	38 x	8
.551.RE	51 x	8
.564.8.RE	64 x	8

TURBO CYLINDRICAL



Ref No.	L (mm)	Ø (mm)
001.108.RE	8 x	3
.112.RE	12 x	4.5
.120.RE	20 x	6
.125.RE	25 x	6
.130.RE	30 x	6
.140.RE	40 x	8
.150.RE	50 x	8
.160.RE	60 x	10

'TURBO' STIRRER BARS

Extra power Samarium-Cobalt magnets

TURBO FLUTE

Turbo Flute is a high power multi-faceted stirrer for general use.

Ref No.	L (mm)	Ht (mm)
001.3450.RE	50	x 21



Turbo Block has twin TURBO magnets inserted in a solid body. Very effective stirring especially in viscous media.

Ref No.	Magnet (mm)		Block (mm)			Hole
	L	Ø	W	Ht	D	Ø (mm)
001.32040.RE	40	x 10	34	x 14	x 14	8
.32055.RE	55	x 12	44	x 18	x 14	8
.32090.RE	90	x 24	80	x 30	x 25	13

TURBO BLOCK



TURBO BOXED SETS

Turbo Boxed Sets include an assortment of useful sizes of stirrer bar in a re-usable container.

Ref No.	No. of Bars	L (mm)	Ø (mm)	Qty
001.3035.RE	10	10	x 6	3
		15	x 10	3
		25	x 14	3
		50	x 24	1

TURBO ELLIPTICAL



Ref No.	No. of Bars	L (mm)	Ø (mm)	Qty
001.3036.RE	14	8	x 3	2
		12	x 4.5	2
		20	x 6	2
		25	x 6	2
		30	x 6	2
		40	x 8	2
		50	x 8	1
		60	x 10	1

TURBO CYLINDRICAL



PTFE used in the manufacture of COWIE® PTFE Laboratory Products is pure, virgin material which conforms to FDA and USP Class VI requirements.

RETRIEVERS



Retrievers are for the removal of stirrer magnets from vessels of all kinds. The polypropylene version has a hanging ring.

PTFE

Ref No.	L (mm)	Ø (mm)
004.150	150	x 10
.250	250	x 10
.350	350	x 10
.450	450	x 10

PTFE FLEXIBLE

Ref No.	L (mm)	Ø (mm)
004.330F	330	x 10

POLYPROPYLENE

Ref No.	L (mm)	Ø (mm)
004.1300	300	x 10
.1350	350	x 10
.1450	450	x 10

PTFE TURBO

Ref No.	L (mm)	Ø (mm)
004.150.RE	150	x 10
.250.RE	250	x 10
.350.RE	350	x 10
.450.RE	450	x 10

PTFE TURBO - FOR GIANT STIRRER BARS

Ref No.	L (mm)	Ø (mm)
004.2350.RE	350	x 18
.2450.RE	450	x 18

STIRRING RODS



Stirring Rods are available in two versions. Pure PTFE solid rod with tapered end and pure PTFE with mild steel core. The version with steel core can be bent into a permanent shape. Inert and will not scratch, use up to 280°C.

STEEL CORE

Ref No.	L (mm)	Ø (mm)
003.100	100	x 6
.150	150	x 6
.200	200	x 6
.250	250	x 6
.300	300	x 6
.350	350	x 6
.400	400	x 6

SOLID PTFE

Ref No.	L (mm)	Ø (mm)
003.1100	100	x 8
.1150	150	x 8
.1200	200	x 8
.1250	250	x 8
.1300	300	x 8

CUSTOM MANUFACTURE OF PTFE STIRRER BARS

We manufacture Custom PTFE Stirrer Bars in a huge range of shapes and sizes.

Our service includes the supply of Custom PTFE Stirrer Bars from a simple item through to the original design, development, verification and validation of more complex shapes. We offer this service directly to users and Original Equipment Manufacturers (OEM's) and include customised packaging and private labelling.



COWIE® use only Pure Virgin PTFE which -

- **Complies with FDA 21 CFR 177.1550** and may be used as articles or components of articles intended to contact food.
- Has been certified in accordance with USP protocol, and specifically meets **the requirements of USP 27, NF22, 2004 for USP Class VI Plastics** at 70°C.
- **Is free from animal derived components (ADCF).**
- Has **no additional ingredients** or processing aids added during the manufacturing process.



Full Traceability and Change Control Compliance is available upon request.

If you require any further information on the supply of Custom PTFE Stirrer Bars or other encapsulated products, please send your enquiry to -

enquiries@cowie.com

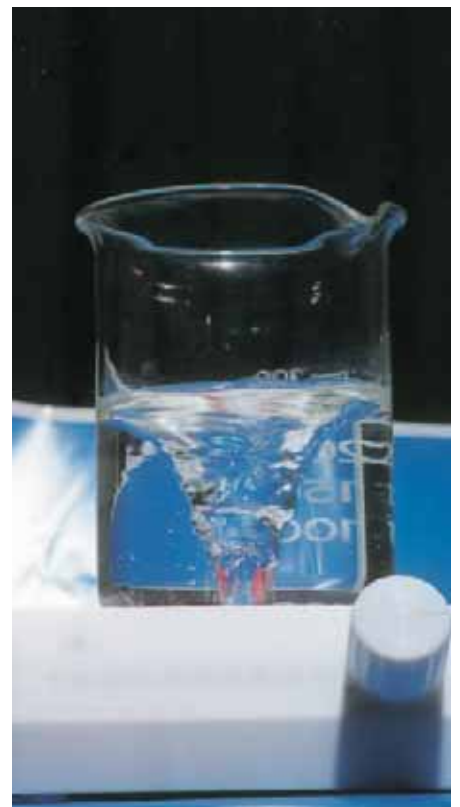

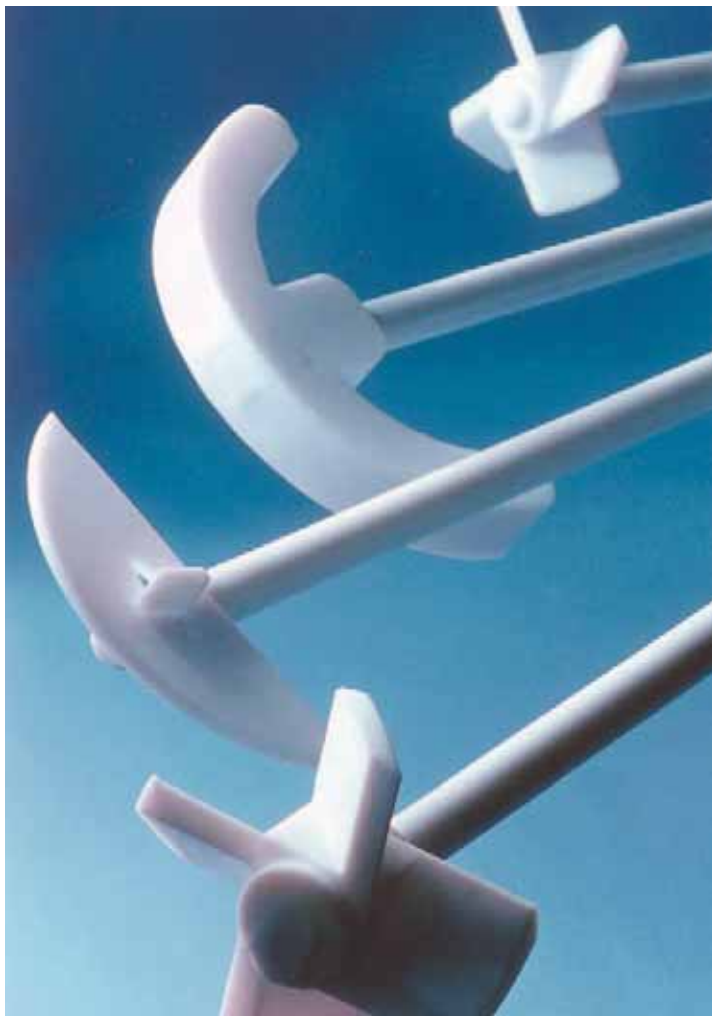

A complete range of High Performance Shaft Stirring Equipment to meet the needs of Laboratory, Pilot Plant and Small Scale manufacture.

PTFE used in the manufacture of COWIE® PTFE Laboratory Products is pure, virgin material, which conforms to FDA and USP Class VI requirements.

- **One piece fused construction**
- **Chemically Inert**
- **Designed to reduce contamination and simplify cleaning**
- **Non-scratch**

We offer a complete custom manufacturing service for PTFE Shaft Stirrers to meet your exact requirements.

UNIVERSAL STIRRER GUIDE FOR STANDARD TAPER GROUND GLASS JOINTS

COWIE® Universal Stirrer Guides for use with standard taper ground glass joints can be used with PTFE Shaft Stirrers and glass and metal shaft stirrers.

Unique features of the design are a permanently loaded Composite PTFE/PEEK Seal and a Glass Ball-Bearing for rigidity and smoothness of operation.

- Exceptional chemical resistance
- Anti-whip and reduced vibration
- Vacuum (5mmHg) and pressure (3-5psi) performance
- No shedding
- Maximum recommended speeds; continuous 500rpm, intermittent 800rpm

Replacement parts available.

FULL LENGTH 'A' TYPE CONE

Ref No.	Shaft Ø (mm)	'A' Cone	Height (mm) excl. joint	Guide Ø (mm)
005.101.1.7	6	19/22	96	45
.102.7	6	24/40	96	45
.104.7	8	24/40	96	45
.105.7	10	24/40	96	45
.106.7	10	29/42	96	45
.108.7	12	29/42	110	55
.111.7	16	34/45	110	55
.112.7	16	45/50	110	55

MEDIUM LENGTH 'B' TYPE CONE

Ref No.	Shaft Ø (mm)	'B' Cone	Height (mm) excl. joint	Guide Ø (mm)
005.201.7	6	19/26	96	45
.202.7	6	24/29	96	45
.203.7	8	19/26	96	45
.204.7	8	24/29	96	45
.205.7	10	24/29	96	45
.206.7	10	29/32	96	45
.207.7	10	34/35	96	45
.208.7	12	29/32	110	55
.209.7	12	34/35	110	55
.211.7	16	34/35	110	55
.212.7	16	45/40	110	55

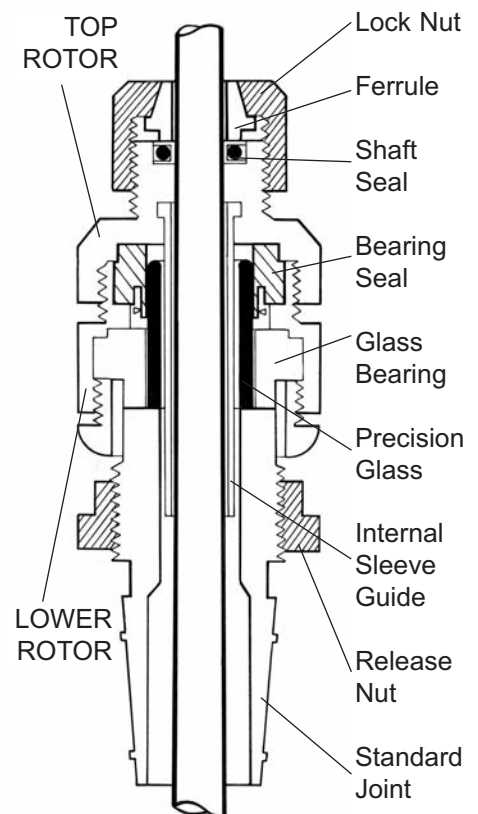

HIGH PERFORMANCE (HP) SHAFT GUIDE FOR STANDARD TAPER GROUND GLASS JOINTS



COWIE® HP Shaft Guides provide an effective guide for use with **GLASS** and **METAL** Shaft Stirrers over a wide range of temperature without shedding particles from a specially formulated PTFE-PEEK seal whilst maintaining vacuum.

In the version designated .PK a moulded-in PTFE-PEEK guide ring located at the end of the taper provides a guide to assist alignment of the shaft.

For the PEEK version use the suffix .PK - eg, 005.0.0619.PK

Note: PEEK has reduced chemical resistance compared to PTFE and may be affected by acids, phenols and halogen based compounds.

The maximum recommended speeds are 500rpm continuous or 800rpm intermittent.

Replacement parts available.

FULL LENGTH 'A' TYPE

Ref No.	Shaft Ø (mm)	'A' Cone	Height (mm) excl. joint	Ring Ø (mm)
005.0.0619	6	19/22	60	42
.0.0624	6	24/40	60	42
.0.0819	8	19/38	60	42
.0.0824	8	24/40	60	42
.0.1024	10	24/40	60	42
.0.1029	10	29/42	60	50
.0.1034	10	34/45	60	50
.0.1045	10	45/50	60	58
.0.1229	12	29/42	70	50
.0.1634	16	34/45	70	50
.0.1945	19	45/50	70	58

MEDIUM LENGTH 'B' TYPE

Ref No.	Shaft Ø (mm)	'B' Cone	Height (mm) excl. joint	Ring Ø (mm)
005.00.0619	6	19/26	60	42
.00.0624	6	24/29	60	42
.00.0819	8	19/26	60	42
.00.0824	8	24/29	60	42
.00.1024	10	24/29	60	42
.00.1029	10	29/32	60	58
.00.1045	10	45/40	60	50
.00.1229	12	29/32	60	50
.00.1634	16	34/35	70	50
.00.1645	16	45/40	70	58
.00.1945	19	45/40	70	58

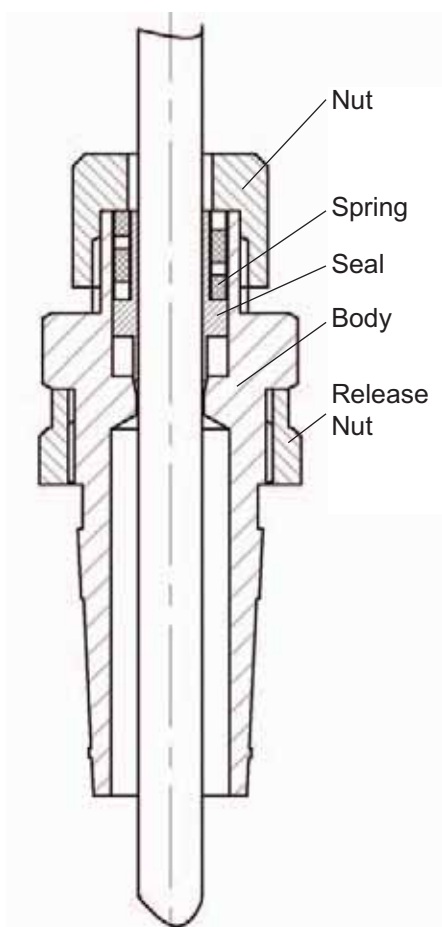

PTFE used in the manufacture of COWIE® PTFE Laboratory Products is pure, virgin material which conforms to FDA and USP Class VI requirements.

Shaft Stirrers have a unique, fully moulded construction featuring a PTFE rotor moulded to a fully PTFE encapsulated steel reinforced drive shaft.

- **Chemically inert**
- **Easy to clean**
- **No cross contamination**
- **Unbreakable**
- **Non Scratch**
- **Use up to ca. 280°C**

Plus

- **Exposed stainless steel core version (EX) for extra rigid clamping in the drive chuck**
- **Exposed length 50mm**

Ref No.	Shaft Ø (mm)	Length (mm)	Rotor Ø (mm)
005.230.2	6	300	40
.240.2	6	400	40
.250.2	6	500	50
.230.8.2	8	300	40
.240.8.2	8	400	40
.250.8.2	8	500	50
.255.2	9.5	550	60
.265.2	9.5	650	60
.0265.2	9.5	650EX	60
.0275.2	9.5	750EX	60
.255.10.2	10	550	70
.0265.10.2	10	650EX	70
.0275.10.2	10	750EX	70
.0265.12.2	12	650EX	80
.0275.12.2	12	750EX	80
.02100.12.2	12	1000EX	80
.0275.16.2	16	750EX	80
.0275.16.1.2	16	750EX	100
.02100.16.2	16	1000EX	100
.02100.16.1.2	16	1000EX	120

Ref No.	Shaft Ø (mm)	Length (mm)	Rotor Ø (mm)
005.430.2	6	300	40
.440.2	6	400	40
.450.2	6	500	50
.430.8.2	8	300	40
.440.8.2	8	400	40
.450.8.2	8	500	50
.455.2	9.5	550	70
.465.2	9.5	650	70
.0465.2	9.5	650EX	70
.0475.2	9.5	750EX	70
.455.10.2	10	550	70
.0465.10.2	10	650EX	70
.0475.10.2	10	750EX	70
.0465.12.2	12	650EX	80
.0475.12.2	12	750EX	80
.04100.12.2	12	1000EX	80
.0475.16.2	16	750EX	80
.04100.16.2	16	1000EX	80

SHAFT STIRRERS



Exposed End

SCREW PROPELLER



CENTRIFUGAL



ANCHOR



Ref No.	Shaft Ø (mm)	Length (mm)	Rotor Ø (mm)
005.330.2	6	300	80
.340.2	6	400	80
.350.2	6	500	80
.330.8.2	8	300	80
.340.8.2	8	400	80
.350.8.2	8	500	80
.355.2	9.5	550	100
.365.2	9.5	650	100
.355.1.2	9.5	550	140
.365.1.2	9.5	650	140
.0365.1.2	9.5	650EX	140
.0375.1.2	9.5	750EX	140
.355.10.2	10	550	100
.0365.10.2	10	650EX	140
.0375.10.2	10	750EX	140
.0365.12.2	12	650EX	140
.0375.12.2	12	750EX	140
.03100.12.2	12	1000EX	140
.0375.16.2	16	750EX	140
.0375.16.1.2	16	750EX	180
.03100.16.2	16	1000EX	140
.03100.16.1.2	16	1000EX	180

RETREAT CURVE



Retreat Curve Shaft Stirrers are a fully moulded product with a retreat angle of 30°.

Ref No.	Shaft Ø (mm)	Length (mm)	Rotor Ø (mm)	Blade Ht (mm)
005.80850.300	8	300	50	10
.80875.300	8	300	75	15
.80850.400	8	400	50	10
.80875.400	8	400	75	15
.81050.400	10	400	50	10
.81075.400	10	400	75	15
.81050.500	10	500	50	10
.81075.500	10	500	75	15

PLAIN SHAFTS



Plain Shafts have a PTFE encapsulated stainless steel core with exposed end.

Ref No.	Shaft Ø (mm)	End Ø (mm)	Length Ø (mm)
005.100830EX	8	5	300
.100850EX	8	5	500
.101030EX	10	6.35	300
.101050EX	10	6.35	500
.101065EX	10	6.35	650
.101250EX	12	6.35	500
.101265EX	12	6.35	650
.101275EX	12	6.35	750
.1016750EX	16	10	750
.1016100EX	16	10	1000

Shafts for Blades are for use with PTFE Stirrer Blades series 002.XXX (see below).

Ref No.	Shaft Ø (mm)	Length (mm)
005.530.1	6	300
.540.1	6	400
.550.1	6	500
.530.8.1	8	300
.540.8.1	8	400
.550.8.1	8	500
.555.1	9.5	550
.565.1	9.5	650
.0565.1	9.5	650EX
.0575.1	9.5	750EX
.0565.10.1	10	650EX
.0575.10.1	10	750EX
.05100.10.1	10	1000EX
.0565.12.1	12	650EX
.0575.12.1	12	750EX
.05100.12.1	12	1000EX
.0575.16.1	16	750EX
.05100.16.1	16	1000EX

SHAFTS FOR BLADES



Stirrer Blades fit all standard shafts for blades, totally inert and non-scratch. Hole diam 6.5mm, 3.2mm thick, PTFE Shafts for these blades are 005.5XX Series (see above).

SQUARE END

Ref No.	W (mm)	Ht (mm)
002.052.1	52 x	14
.076.1	76 x	19
.090.1	90 x	28

PLAIN END

Ref No.	W (mm)	Ht (mm)
002.1065.1	65 x	25
.1075.1	75 x	25
.1105.1	105 x	25
.1125.1	125 x	25
.1150.1	150 x	25

STIRRER BLADES



PTFE used in the manufacture of COWIE® PTFE Laboratory Products is pure, virgin material which conforms to FDA and USP Class VI requirements.

ADJUSTABLE ROTORS



Adjustable Rotors slide over standard shafts and lock in place to give the most effective stirring patterns. All PTFE with glass filled PTFE lock nut. Rotor diameters are nominal.

4 BLADE ANGLED TYPE 45° METRIC

Ref No.	Shaft Ø (mm)	Rotor Ø (mm)
005.606040	6	40
.608040	8	40
.610060	10	60
.610090	10	90
.612070	12	70
.612090	12	90
.616100	16	100

4 BLADE ANGLED TYPE 45° IMPERIAL

Ref No.	Shaft Ø (in)	Rotor Ø (in)
005.6.250.15	1/4	1½
.6.313.15	5/16	1½
.6.375.25	3/8	2½
.6.500.35	1/2	3½
.6.625.40	5/8	4



FLAT TYPE METRIC

Ref No.	Shaft Ø (mm)	Rotor Ø (mm)
005.706070	6	70
.708070	8	70
.710070	10	70
.710100	10	100
.712100	12	100
.712150	12	150
.716100	16	100
.716150	16	150

FLAT TYPE IMPERIAL

Ref No.	Shaft Ø (in)	Rotor Ø (in)
005.7.250.3	1/4	3
.7.313.3	5/16	3
.7.375.3	3/8	3
.7.500.4	1/2	4
.7.625.6	5/8	6

ADJUSTABLE TURBINE



Adjustable Turbine Shaft Stirrers are for use with plain glass, metal or PTFE shafts.

Ref No.	Shaft Ø (mm)	Rotor Ø (mm)
005.90850	8	50
.90875	8	75
.91075	10	75
.910100	10	100
.91275	12	75
.912100	12	100
.916100	16	100
.916150	16	150

CUSTOM OPTIONS FOR SHAFT STIRRING

COWIE® offer a complete custom design and manufacturing service for Shaft Stirring Products.

Our service includes the supply of Custom Shaft Stirring Products, whether it be a simple size adjustment of a standard option through to the original design, development, verification and validation of more complex shapes. We can offer this service directly to users and Original Equipment Manufacturers (OEM's).



Cowie use only Pure Virgin PTFE which -

- Has been certified by the manufacturer in accordance with USP protocol, and specifically meets **the requirements of USP 27, NF22, 2004 for USP Class VI Plastics** at 70°C.
- Is **free from animal derived components** (ADCF).
- Has **no additional ingredients** or processing aids added to during the manufacturing process.



Full Traceability and Change Control Compliance is available upon request.

If you require any further information on the supply of Custom PTFE Shaft Stirring Products, please send your enquiry to -

enquiries@cowie.com





A complete range of high performance process chemistry equipment to meet the needs of laboratory and small scale manufacture.

PTFE used in the manufacture of COWIE® Laboratory Products is pure, virgin material, which conforms to FDA and USP Class VI requirements.

- **Chemically inert**
- **Reduce contamination and simplify cleaning**
- **Non-scratch**
- **Reduce breakages**
- **Improved safety**

We offer a complete custom manufacturing service for PTFE Reactor Lids, Fittings and Accessories to meet your exact requirements.

REACTOR LID SYSTEM

Many of today's process chemistry, pharmaceutical and biotech laboratories and manufacturing units face an increasing demand to use equipment which is **Pure, Chemically Resistant, Cleanable** and **Durable**.

The COWIE® Reactor Lid System is designed to meet these demands and provide a **versatile** and **cost effective** means for the assembly of a whole range of equipment in flanged reactors and similar vessels and offers these unique features -

- Screw-in assembly of fittings to give flexibility, versatility and significant cost savings.
- All fittings are interchangeable for the same thread sizes.
- Can accommodate all usual ancillary equipment, condensers, probes, etc.
- Improved durability and safety compared to conventional glass lids.
- High mechanical strength to support large probes and other equipment.
- Improved thermal insulation.
- Reduced condensation.

Standard Reactor Lids fit vessels with 60, 100, 150 and 200mm Duran® type flanges. Additionally we manufacture custom lids to meet your exact requirements including lids manufactured from TFM, Glass Filled PTFE and PTFE Laminates - see page 44 for further details.

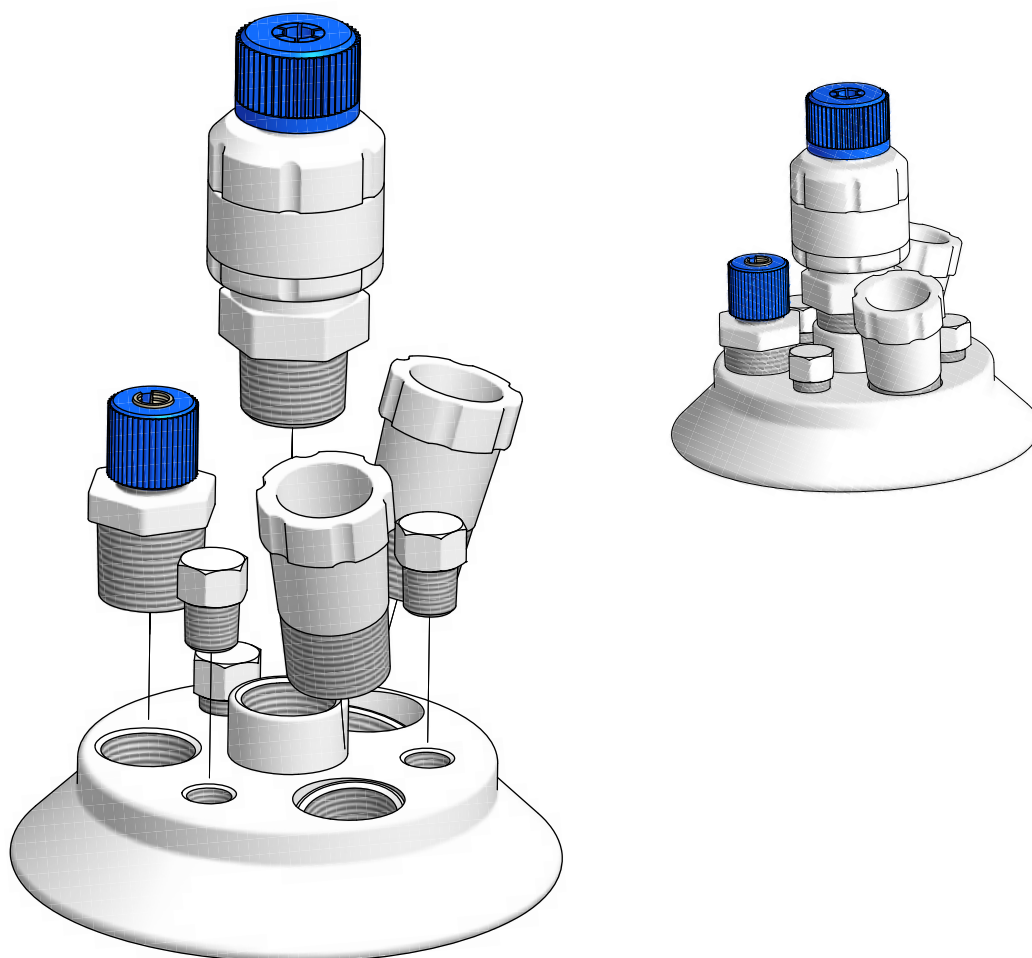

60mm PRE-ASSEMBLED REACTOR LIDS

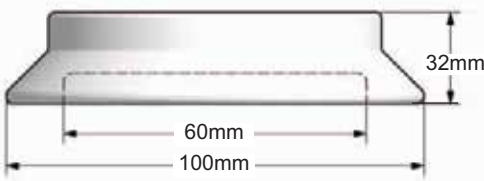

Pre-assembled Reactor Lids to fit 60mm ID Duran® type flanges.

Taper Joints are removable and interchangeable. For a complete range of Reactor Lid NPT Fittings and Accessories, please see pages 49 - 57.



Ref. PC715.060.001

Base	Type	Taper Joint	Port Size
Centre Port	Vertical	24/-	1/2" NPT
Side Port 1	10°x10° Compound Angle	14/-	1/2" NPT
Side Port 2	10°x10° Compound Angle	14/-	1/2" NPT
Side Port 3	10°x10° Compound Angle	14/-	1/2" NPT



Ref. PC715.060.002

Base	Type	Taper Joint	Port Size
Centre Port	Vertical	24/-	1/2" NPT
Side Port 1	10°x10° Compound Angle	19/-	1/2" NPT
Side Port 2	10°x10° Compound Angle	19/-	1/2" NPT
Side Port 3	10°x10° Compound Angle	19/-	1/2" NPT

100mm PRE-ASSEMBLED REACTOR LIDS

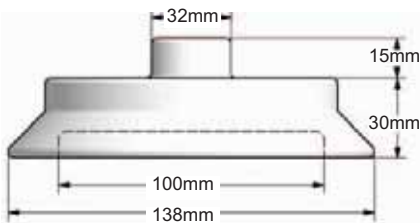

Pre-assembled Reactor Lids to fit 100mm ID Duran® type flanges.

Taper Joints are removable and interchangeable. For a complete range of Reactor Lid NPT Fittings and Accessories, please see pages 49 - 57.

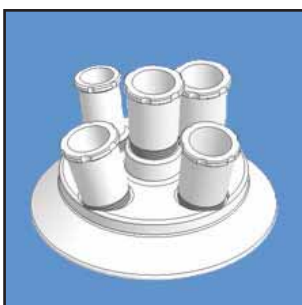

Ref. PC715.100.001

Base	Type	Taper Joint	Port Size
Centre Port	Vertical	24/-	3/4" NPT
Side Port 1	Vertical	24/-	3/4" NPT
Side Port 2	10° Angle	24/-	3/4" NPT
Side Port 3	10° Angle	19/-	3/4" NPT
Side Port 4	10°x10° Compound Angle	24/-	3/4" NPT



Ref. PC715.100.002

Base	Type	Taper Joint	Port Size
Centre Port	Vertical	29/-	3/4" NPT
Side Port 1	Vertical	24/-	3/4" NPT
Side Port 2	10° Angle	19/-	3/4" NPT
Side Port 3	10° Angle	24/-	3/4" NPT
Side Port 4	10°x10° Compound Angle	29/-	3/4" NPT

150mm PRE-ASSEMBLED REACTOR LIDS

Pre-assembled Reactor Lids to fit 150mm ID Duran® type flanges.

Taper Joints are removable and interchangeable. For a complete range of Reactor Lid NPY Fittings and Accessories, please see pages 49 - 57.

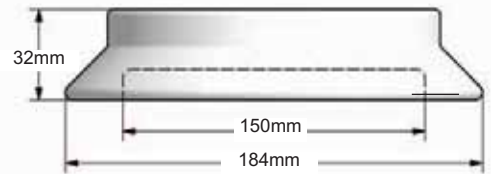

Ref. PC715.150.001

Base	Type	Taper Joint	Port Size
Centre Port	Vertical	29/-	1" NPT
Side Port 1	Vertical	24/-	1" NPT
Side Port 2	Vertical	29/-	1" NPT
Side Port 3	10° Angle	45/-	1" NPT
Side Port 4	10°x10° Compound Angle	29/-	1" NPT



Ref. PC715.150.002

Base	Type	Taper Joint	Port Size
Centre Port	Vertical	34/-	1" NPT
Side Port 1	Vertical	29/-	1" NPT
Side Port 2	Vertical	29/-	1" NPT
Side Port 3	10° Angle	45/-	1" NPT
Side Port 4	10°x10° Compound Angle	29/-	1" NPT



200mm PRE-ASSEMBLED REACTOR LIDS

Pre-assembled Reactor Lids to fit 200mm ID Duran® type flanges.

Taper Joints are removable and interchangeable. For a complete range of Reactor Lid NPT Fittings and Accessories, please see pages 49 - 57.

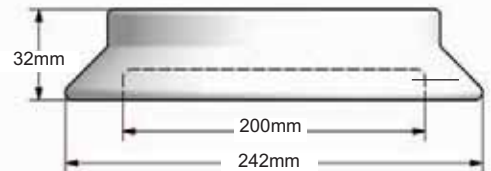

Ref. PC715.200.001

Base	Type	Taper Joint	Port Size
Centre Port	Vertical	34/-	1" NPT
Side Port 1	Vertical	29/-	1" NPT
Side Port 2	Vertical	29/-	1" NPT
Side Port 3	10° Angle	29/-	1" NPT
Side Port 4	10°x10° Compound Angle	29/-	1" NPT
Side Port 5	10° Angle	45/-	1½" NPT



Ref. PC715.200.002

Base	Type	Taper Joint	Port Size
Centre Port	Vertical	45/-	1" NPT
Side Port 1	Vertical	34/-	1" NPT
Side Port 2	Vertical	45/-	1" NPT
Side Port 3	10° Angle	24/-	1" NPT
Side Port 4	10°x10° Compound Angle	29/-	1" NPT
Side Port 5	10° Angle	45/-	1½" NPT



PTFE REACTOR LIDS SELF ASSEMBLY

LID ASSEMBLY

1. Select the basic lid according to the flange size and number of ports required - pages 47 & 48.
2. Select the fittings required from the various options on pages 49 to 52.
3. Screw the fittings into the ports to complete the assembly.
4. Fitting exchange - Unscrew the existing fitting and screw in its place the new fitting. Fittings can be purchased separately.

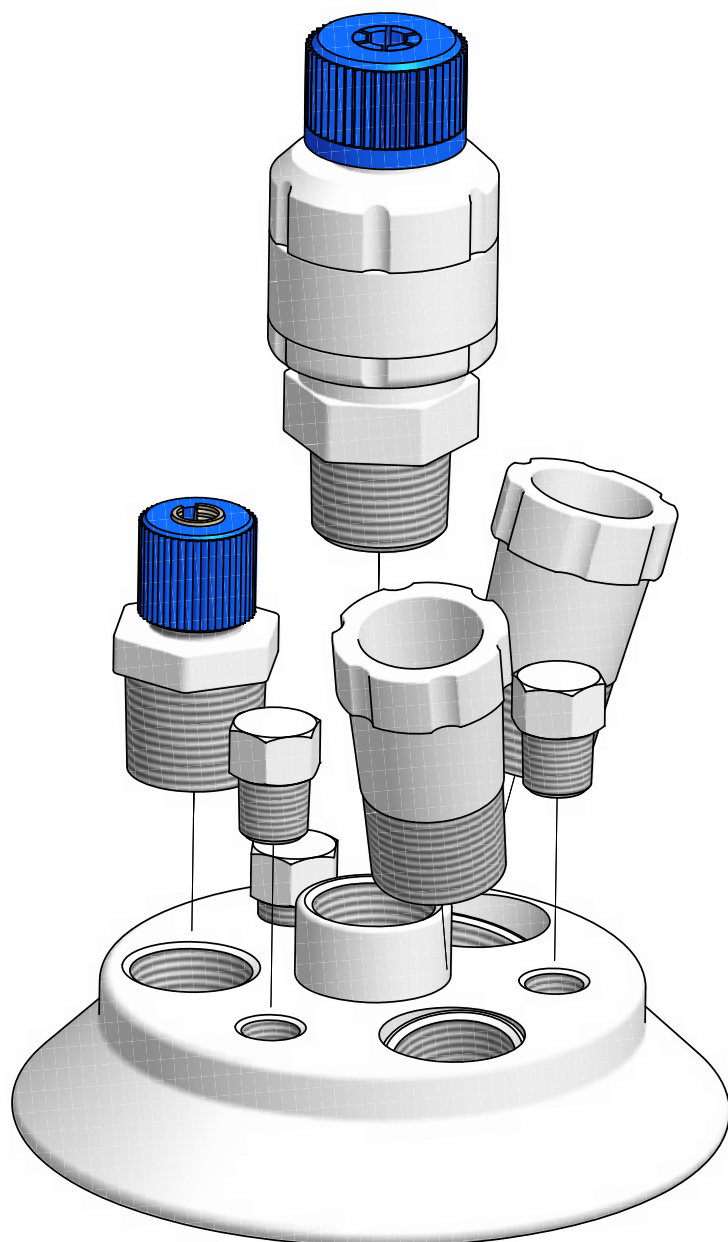

PTFE used in the manufacture of COWIE® PTFE Laboratory Products is pure, virgin material which conforms to FDA and USP Class VI requirements.

60mm LIDS FOR SELF ASSEMBLY

Reactor Lids in Pure PTFE to fit 60mm ID Schott® type flanges, **supplied without fittings.**
 For a complete range of Reactor Lid NPT Fittings and Accessories, please see pages 49 - 57.
 The use of an extension adapter will provide extra space when using multiple ports - see page 52.

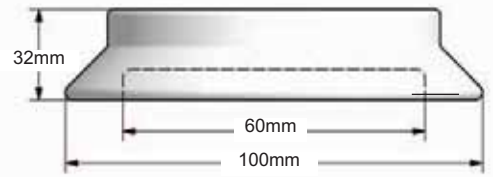

Ref. PC705.060.003

Port	Qty	NPT Thread
A	1	1/2" Vertical Centre Port
B	2	1/2" 10° x 10° Compound Angle
C	1	1/4" Vertical

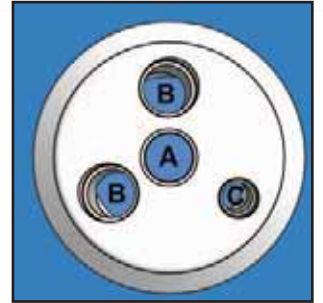

Ref. PC705.060.004

Port	Qty	NPT Thread
A	1	1/2" Vertical Centre Port
B	3	1/2" 10° x 10° Compound Angle

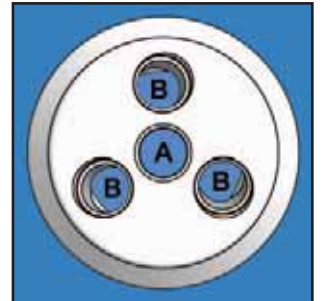

100mm LIDS FOR SELF ASSEMBLY

Reactor Lids in Pure PTFE to fit 100mm ID Schott® type flanges, **supplied without fittings.**

For a complete range of Reactor Lid NPT Fittings and Accessories, please see pages 49 - 57.

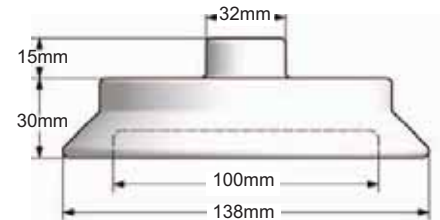

Ref. PC705.100.002

Port	Qty	NPT Thread
A	1	3/4" Vertical Raised Centre Port
B	2	3/4" Vertical
C	1	1" 10° x 10° Compound Angle
D	3	1/4" Vertical

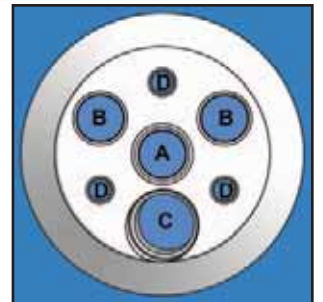

Ref. PC705.100.003

Port	Qty	NPT Thread
A	1	3/4" Vertical Raised Centre Port
B	2	3/4" Vertical
C	2	3/4" 10° Angle
D	2	1/4" Vertical

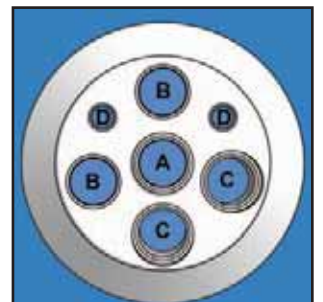

150mm LIDS FOR SELF ASSEMBLY

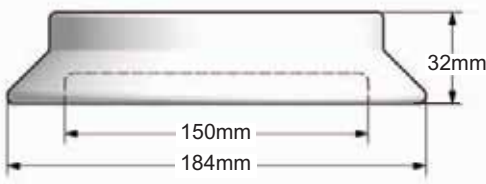

Reactor Lids in Pure PTFE to fit 150mm ID Duran® type flanges, **supplied without fittings.**

For a complete range of Reactor Lid NPT Fittings and Accessories, please see pages 49 - 57.

Ref. PC705.150.002

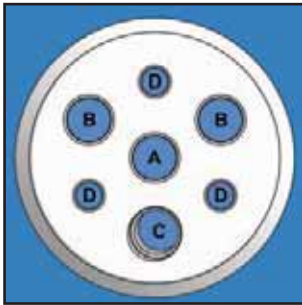

Port	Qty	NPT Thread
A	1	1" Vertical Centre Port
B	2	1" Vertical
C	1	1" 10° x 10° Compound Angle
D	3	½" Vertical

Ref. PC705.150.003



Port	Qty	NPT Thread
A	1	1" Vertical Centre Port
B	3	1" Vertical
C	1	1" 10° x 10° Compound Angle
D	4	½" Vertical

200mm LIDS FOR SELF ASSEMBLY

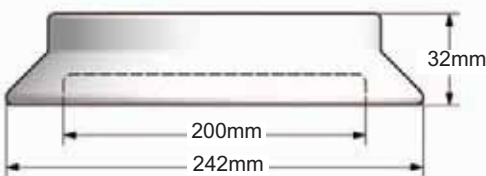

Reactor Lids in Pure PTFE to fit 200mm ID Duran® type flanges, **supplied without fittings.**

For a complete range of Reactor Lid NPT Fittings and Accessories, please see pages 49 - 57.

Ref. PC705.200.002

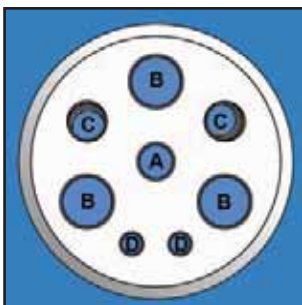

Port	Qty	NPT Thread
A	1	1" Vertical Centre Port
B	3	1½" Vertical
C	2	1" 10° x 10° Compound Angle
D	2	½" Vertical

Ref. PC705.200.003

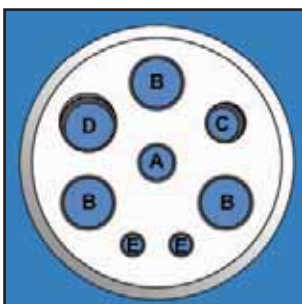

Port	Qty	NPT Thread
A	1	1" Vertical Centre Port
B	3	1½" Vertical
C	1	1" 10° Angle
D	1	1½" 10° x 10° Compound Angle
E	2	½" Vertical

STANDARD TAPER JOINTS FOR NPT PORTS

Standard Taper Joint Fittings for use with COWIE® PTFE Reactor Lids.

Suitable for 'A' and 'B' length jointware.

To assemble simply screw the tapered NPT joint into a corresponding NPT port of the reactor lid.

Ref No.	NPT Thread	Cone Taper	Dimensions H x Ø (mm)
PC711.1413	1/2"	14/-	45 x 21.5
.1913	1/2"	19/-	50 x 27
.2413	1/2"	24/-	67 x 34
.2913	1/2"	29/-	68 x 40
.1919	3/4"	19/-	55 x 27
.2419	3/4"	24/-	55 x 34
.2919	3/4"	29/-	68 x 40
.3419	3/4"	34/-	75 x 47
.4519	3/4"	45/-	89 x 58
.2425	1"	24/-	60 x 34
.2925	1"	29/-	60 x 40
.3425	1"	34/-	75 x 47
.4525	1"	45/-	90 x 58
.2438	1 1/2"	24/-	55 x 48
.2938	1 1/2"	29/-	55 x 48
.3438	1 1/2"	34/-	55 x 48
.4538	1 1/2"	45/-	80 x 61



BLANKING NUTS FOR NPT PORTS

NPT Blanking Nuts/Plugs are used to seal unused ports. To assemble simply screw the NPT Blanking Nut into a corresponding NPT port of the reactor lid.

Ref No.	To fit Port Size
PC702.025	1/4" NPT
.050	1/2" NPT
.075	3/4" NPT
.100	1" NPT
.150	1 1/2" NPT



Male/Female NPT Extension Adapters optimise the use of NPT entry ports by the provision of additional port sizes and raising the height of the entry port from the lid. This gives even more flexibility of assembly and enables a greater range of fittings to be used - this is especially the case for 60mm lids with multiple ports where the use of an extension adapter allows the use of a central stirrer guide.

NPT Extension Adapters are manufactured in Glass Filled PTFE for improved mechanical strength.

EXTENSION ADAPTERS



Ref No.	Male NPT	Female NPT	Nominal Height (mm)	Fits Max Shaft Ø (mm)
PC713.025050.GF	1/4"	1/2"	40	8.5
.050050.GF	1/2"	1/2"	36	14
.050075.GF	1/2"	3/4"	46	14
.075075.GF	3/4"	3/4"	46	18
.075100.GF	3/4"	1"	46	18
.100100.GF	1"	1"	43	24
.100150.GF	1"	1 1/2"	43	24

NPT - COMPRESSION SCREW FITTINGS



Compression Fittings are used with PTFE Reactor Lids to hold items such as temperature probes and sampling tubes securely in place. Compression fittings are manufactured from pure PTFE and include a PEEK olive to give a secure grip.

Compression fittings for standard taper ground glass joints are also available, see page 11 for details.

To define the Reference Number of the required part add the bore size suffix to the required reference.

Example:

A fitting with a 1/4" NPT and 6mm bore is - PC701.025.06

METRIC

Ref No.	NPT Size	Bore Size (mm)									
		3	6	7	8	9	12	14	16	19	25
PC701.025.XX	1/4"	.03	.06								
.050.XX	1/2"		.06	.07	.08	.09	.12	.14			
.075.XX	3/4"				.08		.12	.14	.16	.19	
.100.XX	1"				.08		.12	.14	.16	.19	.25

IMPERIAL

Ref No.	NPT Size	Bore Size (in)								
		1/8"	1/4"	5/16"	1/2"	9/16"	5/8"	3/4"	1"	
PC701.025.XXX	1/4"	.125	.250							
.050.XXX	1/2"		.250	.312	.500	.560				
.075.XXX	3/4"			.312	.500	.560	.625	.750		
.100.XXX	1"				.500	.560	.625	.750	.1000	

REPLACEMENT PARTS

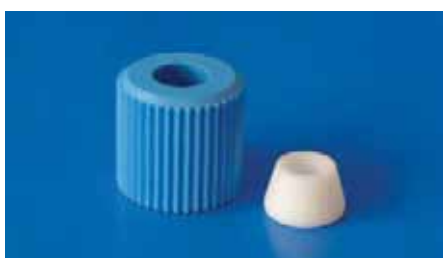

Seal pack includes 1 clamp nut, 1 nut and 1 olive. Olive pack includes 5 replacement olives.

METRIC

Ref No.	Description	Bore Size (mm)									
		3	6	7	8	9	12	14	16	19	25
PC701.XXX	Seal Pack	.003	.006	.007	.008	.009	.012	.014	.016	.019	.025
.XX	Olive (5/pk)	.03	.06	.07	.08	.09	.12	.14	.16	.19	.25

IMPERIAL

Ref No.	Description	Bore Size (in)								
		1/8"	1/4"	5/16"	1/2"	9/16"	5/8"	3/4"	1"	
PC701.XXXX	Seal Pack	.0125	.0250	.0312	.0500	.0560	.0625	.0750	.01000	
.XXX	Olive (5/pk)	.125	.250	.312	.500	.560	.625	.750	.1000	

PTFE used in the manufacture of COWIE® PTFE Laboratory Products is pure, virgin material which conforms to FDA and USP Class VI requirements.

PTFE PLUGS

Plugs are used to seal a compression fitting without the need to remove the compression fitting from the reactor lid.



METRIC

Ref No.	Bore Size (mm)										
	3	6	7	8	9	12	14	16	19	25	
PC703.XX	.03	.06	.07	.08	.09	.12	.14	.16	.19	.25	

IMPERIAL

Ref No.	Bore Size (in)									
	1/8"	1/4"	5/16"	1/2"	9/16"	5/8"	3/4"	1"		

Blanking Lids have no ports and are designed to provide a seal for reaction vessels. Lids fit 60mm, 100mm, 150mm, 200mm Duran® type flanges and have a central handle to facilitate easy handling.

Ref No.	Flange ID (mm)	Ø OD (mm)	Height (mm)
PC706.060	60	100	16
.100	100	138	20
.150	150	184	20
.200	200	242	20



BLANKING LIDS

Rod Baffles are used to increase agitation and promote thorough mixing. Feature a stainless steel core fully encapsulated in PTFE to give a product which is chemically resistant and non-contaminating. Assemble with corresponding compression fitting.

Ref No.	Shaft Ø (mm)	Shaft L (mm)	Baffle WxDxL (mm)	Total L (mm)
PC708.008.150	8	150	16 x 12 x 150	300
.008.200	8	200	16 x 12 x 150	350
.008.250	8	250	16 x 12 x 150	400
.012.150	12	150	20 x 15 x 200	350
.012.200	12	200	20 x 15 x 200	400
.012.250	12	250	20 x 15 x 200	450
.016.150	16	150	35 x 22 x 250	400
.016.200	16	200	35 x 22 x 250	450
.016.250	16	250	35 x 22 x 250	500



ROD BAFFLES

HIGH PERFORMANCE (HP) SHAFT GUIDE WITH NPT THREAD



COWIE® HP Shaft Guides provide an effective guide for use with **GLASS** and **METAL** Shaft Stirrers over a wide range of temperature without shedding particles from the seal whilst maintaining vacuum. The seal is made from a specially formulated PTFE-PEEK composite and this material is also used to provide a moulded-in guide ring to aid alignment of the shaft.

Note: PEEK has reduced chemical resistance compared to PTFE and may be affected by acids, phenols and halogen based compounds.

The maximum recommended speeds are 500rpm continuous or 800rpm intermittent.

HP Shaft Guides have an NPT thread for direct assembly into COWIE® Reactor Lids.

Ref No.	Shaft Ø (mm)	NPT Thread	Height (mm) excl. joint	Hex (mm)
PC710.0819.PK	8	¾"	63	28 AF
.1019.PK	10	¾"	63	28 AF
.0825.PK	8	1"	67	40 AF
.1025.PK	10	1"	67	40 AF
.1225.PK	12	1"	67	40 AF
.1625.PK	16	1"	80	40 AF
.1925.PK	19	1"	80	40 AF

UNIVERSAL STIRRER GUIDE WITH NPT THREAD



COWIE® Universal Stirrer Guides have an NPT Screw Thread Fitting for direct assembly into COWIE® Reactor Lids or NPT Extension Adapters and can be used with PTFE Shaft Stirrers.

Unique features of the design are a permanently loaded Composite PTFE/PEEK Seal and a Glass Ball-Bearing for rigidity and smoothness of operation.

- Exceptional chemical resistance
- Anti-whip and reduced vibration
- Vacuum (5mmHg) and pressure (3-5psi) performance
- No shedding
- Maximum recommended speeds are

500rpm continuous 500rpm, intermittent 800rpm

Ref No.	Shaft Ø (mm)	NPT Thread	Height (mm) excl. joint	Guide Ø (mm)
PC709.0819	8	¾"	106	44
.1019	10	¾"	106	44
.1219	12	¾"	106	44
.0825	8	1"	110	44
.1025	10	1"	110	44
.1225	12	1"	112	54
.1625	16	1"	112	54

Stirrer Guides and Shaft Guides are also available for Standard Taper Ground Glass Joints - see page 35-36

CUSTOM MANUFACTURE OPTIONS

We manufacture a truly diverse range of Custom Process Chemistry Equipment to meet your specific requirements, including lids manufactured from TFM, Glass Filled PTFE and PTFE Laminates.

Whether you are a User requiring a single item or an Original Equipment Manufacturer (OEM) requiring high volume quantities we offer a service based on over 30 years experience in the manufacture of PTFE products and supported by a Technical Team of chemists and engineers specialising in the properties of PTFE and the use of PTFE products.

Examples of Custom Process Chemistry Equipment

- **Non-Listed Lid sizes and flange types**
Fit all sizes and types of flange.
- **Lids with integral locating rings**
An aid to the location and assembly of Lids in glass reaction vessels.
- **Solid lids with integral fittings**
Fittings are an integral part of the lid and are of especial use in permanent fixtures.
- **Reaction vessels to 10 litre capacity**
Almost any type of reactor with standard flanges or special lid fittings.
- **Baffles**
An aid to improved mixing in stirred reactors.
- **Spargers**
For the efficient distribution of inlet gases into reaction media.
- **Temperature Probes**
A COWIE® speciality and produced with thermocouple and platinum resistance sensors in almost any shape or size.
- **Condensers**
Of interest in systems using HF.
- **Shafts**
Fittings for every description.
- **Filtration units**
In-situ separation of reaction products.
- **Addition funnels**
To aid addition of material.

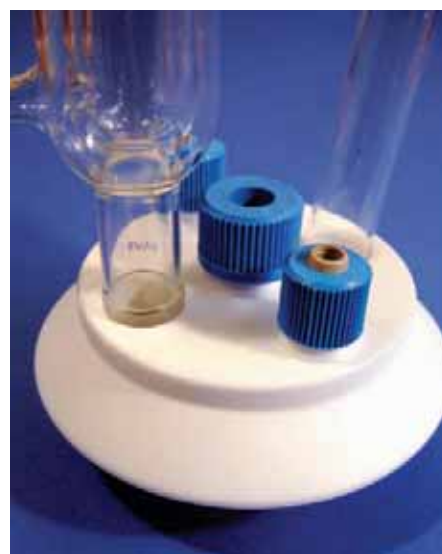

To receive our offer for custom Reactor Lids and Fittings please send your specification, including quantities required to enquiries@cowie.com.



Our dual expertise in the technologies of Temperature Sensing and PTFE Processing enables us to produce a range of fully encapsulated, PTFE Temperature Probes which combine the outstanding properties of PTFE with well-proven thermometric techniques.

- **Outstanding chemical resistance**
- **No contamination of working media**
- **A wide range of operating temperature and tolerances**
- **Almost any shape or size**
- **Give reduced down times and replacements**
- **Can eliminate thermowells**

We offer a complete custom manufacturing service for PTFE Temperature Probes to meet your exact requirements.

PLATINUM RESISTANCE PROBES

COWIE® Platinum Resistance Temperature Probes combine the outstanding properties of PTFE with the reliability and accuracy of Platinum Resistance thermometry.

- Inert and Non Contaminating
- -180°C to +280°C
- Pressure Resistant

All components are fully encapsulated in pure PTFE. The Body has a stainless steel core for rigidity but can be bent. With push-on ferrule.

Sensor: PRT100 Class A. TCR = 3850 ppm/°C.

Cable: 4 Wire; 2 Red, 2 White.
PFA insulated, white PFA oversheath.
1 metre of cable fused to body.
Option to increase cable length.

Response: 50%, 6-14 seconds.

Supplied without plug. Special plugs on request.

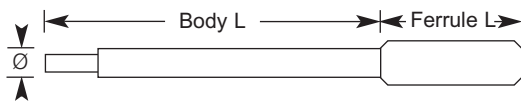

A COWIE® Original Design

Ref No.	Body Ø (mm)	Body L (mm)	Ferrule L (mm)
500.106.1	6	100	35
.206.1	6	200	40
.100.1	7	100	35
.200.1	7	200	40
.307.1	7	300	40
.208.1	8	200	40
.300.1	8	300	40
.400.1	8	400	50
.500.1	9	500	60
.600.1	9	600	60
.700.1	9	700	45
.900.1	9	900	45

For extra cable put total cable length in metres after Reference No.e.g. 500.100.1.5 for 5 metres.

TOTAL IMMERSION

Designed for total immersion, suitable for use in autoclaves and most corrosive liquids.

Sensor: PRT100 Class A

Cable: 4 Core PFA insulated with white PFA over sheath. 1 metre of cable fused to body.
Option to increase cable length.

Supplied without plug.

Ref No.	Body Ø (mm)	Body L (mm)
500.050.1	5	50

For extra cable put total cable length in metres after Reference. e.g. 500.050.1.6 for 6 metres.



THERMOCOUPLE PROBES TYPE K



A COWIE® Original Design

COWIE® Thermocouples combine the outstanding properties of PTFE with the reliability of Thermocouple thermometry.

- Inert and Non Contaminating
- -180°C to +280°C
- Pressure Resistant

All components are fully encapsulated in pure PTFE. The body has a stainless steel core for rigidity but can be bent. With push-on ferrule.

Sensor: Type K Thermocouple

Cable: PFA insulated with PFA oversheath.
1 metre of cable fused to body.
Option to increase cable length.
International Colours:
Cover: Green, +ve Green, -ve White.

Response: 50%, 6-14 seconds.

Supplied with miniplug.

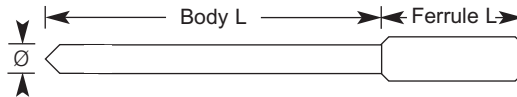

Ref No.	Body Ø(mm)	Body L (mm)	Ferrule L (mm)
600.106.1	6	100	35
.206.1	6	200	40
.101.1	7	100	35
.201.1	7	200	40
.307.1	7	300	40
.208.1	8	200	40
.301.1	8	300	40
.401.1	8	400	50
.501.1	9	500	60
.601.1	9	600	60
.701.1	9	700	45
.901.1	9	900	45

For extra cable put total cable length in metres after Reference No.e.g. 600.101.1.5 for 5 metres.

CUSTOM TEMPERATURE PROBES



We custom manufacture PTFE temperature probes of every description and in any quantity to your exact specification.

For further information on Custom PTFE Temperature Probes please email us at enquiries@cowie.com with your product and quantity requirements.

PLATINUM RESISTANCE BAFFLE PROBES

The dual purpose Platinum Resistance Baffle Probe (PRT100) is for use in reaction systems to increase agitation and promote thorough mixing whilst also acting as a temperature probe. All components are fully encapsulated in PTFE to ensure purity and chemical resistance and have a stainless steel core for rigidity.

Sensor: PRT100 Class A

Cable: 4 Wire; 2 Red, 2 White.
PFA insulated, white PFA oversheath.
1 metre of cable fused to body.
Option to increase cable length.

Supplied without plug.

Ref No.	Shaft Ø (mm)	Shaft L (mm)	Baffle WxDxL (mm)	Total L (mm)
PC707.508.150.1	8	150	16 x 12 x 150	300
.508.200.1	8	200	16 x 12 x 150	350
.508.250.1	8	250	16 x 12 x 150	400
.512.150.1	12	150	20 x 15 x 200	350
.512.200.1	12	200	20 x 15 x 200	400
.512.250.1	12	250	20 x 15 x 200	450
.516.150.1	16	150	35 x 22 x 250	400
.516.200.1	16	200	35 x 22 x 250	450
.516.250.1	16	250	35 x 22 x 250	500



THERMOCOUPLE BAFFLE PROBES

The dual purpose Thermocouple Baffle Probe (Type K) is for use in reaction systems to increase agitation and promote thorough mixing whilst also acting as a temperature probe. All components are fully encapsulated in PTFE to ensure purity and chemical resistance and have a stainless steel core for rigidity.

Sensor: Type K Thermocouple

Cable: PFA insulated with PFA oversheath.
1 metre of cable fused to body.
Option to increase cable length.
International Colours: Cover: Green,
+ve Green, -ve White

Supplied with miniplug not fitted for ease of assembly.

Ref No.	Shaft Ø (mm)	Shaft L (mm)	Baffle WxDxL (mm)	Total L (mm)
PC707.608.150.1	8	150	16 x 12 x 150	300
.608.200.1	8	200	16 x 12 x 150	350
.608.250.1	8	250	16 x 12 x 150	400
.612.150.1	12	150	20 x 15 x 200	350
.612.200.1	12	200	20 x 15 x 200	400
.612.250.1	12	250	20 x 15 x 200	450
.616.150.1	16	150	35 x 22 x 250	400
.616.200.1	16	200	35 x 22 x 250	450
.616.250.1	16	250	35 x 22 x 250	500



GENERAL

Polytetrafluoroethylene (PTFE-Teflon®, Dyneon®, Diakin®) is the most important member of a group of fluoropolymers with a range of unique and useful properties not possessed by any other polymeric material.

The unique properties of PTFE include –

- Almost totally chemically inert
- Exceptional thermal stability
- Electrical and dielectric properties
- Non-stick properties
- Flexural strength

This range of properties means that the scope for the use of PTFE products is potentially very high, however, because of cost considerations and difficulties of fabrication PTFE is generally considered a specialist material for use in highly specific and demanding applications.

STRUCTURE

PTFE is a linear chain polymer of tetrafluoroethylene [TFE] with the repeat structure $[-CF_2-]_n$. The molecular weight of the polymer is very high and this coupled with the protective shield of fluorine atoms around the carbon core provides the basis for the unique properties of PTFE.

RELATED FLUOROPOLYMERS

- **Modified PTFE** (Dyneon® TFM, Teflon® NXT) – A co-polymer of PTFE where a small amount (less than 1%) of a co-monomer such as perfluoropropylvinyl ether is incorporated in the PTFE chain. Properties of the material are similar to PTFE but with improved mechanical properties, reduced porosity and can be self fused.
- **PFA** – A copolymer of TFE and a per-fluoroalkyl ether. PFA has many of the desirable properties of PTFE and is translucent and melt processable. Maximum working temperature is 260°C.
- **FEP** – A copolymer of TFE and hexylfluoropropylene. Exhibits many of the desirable properties of PTFE. High clarity and melt processable. Maximum working temperature 200°C.

CHEMICAL RESISTANCE

Over its operating temperature range the chemical inertness of PTFE is generally considered to be total.

Rare examples of known reactions of PTFE are –

- Slight reversible swelling of PTFE with some fluorinated hydrocarbons, benzyl chloride, dimethylformamide and chloroethanes. At higher temperatures these substances may cause mechanical breakdown by diffusing into the polymer and expanding the structure.
- Molten or dissolved alkali metals, such as sodium in liquid ammonia and sodium in a naphthalene-tetrahydrofuran mixture, will abstract fluorine from the surface of the polymer to leave a black finish (believed to be carbon).
- Reactions with alkali earth, alkali metal oxides and carbonates at temperatures above 350°C have been noted.
- Reactions with fluorine, some fluorine related compounds and chlorine trifluoride have been observed at elevated temperatures and pressures.
- Gases including oxygen, helium and halogens, notably chlorine and bromine, have been reported as reversibly diffusing into PTFE without apparent chemical reaction.
- A vigorous reaction when mixed with finely powdered aluminium and heated.

PTFE – The material of choice when chemical resistance is essential.

PURITY

Virgin, unfilled, PTFE materials are considered to have very high levels of purity.

Typical values –

	PTFE	TFM
	Ng/cm ²	Ng/cm ²
Al	3.7	2.2
Ca	22	11
Cu	21	24
Fe	5	3
Pb	3	2
(Extraction medium 2% Nitric Acid for 2 days at 20°C. Origin – Dyneon®)		

Virgin PTFE and TFM can, therefore, be used in applications where very high levels of purity are required, eg, in trace analysis and semiconductor manufacture.

- **Filled PTFE** - PTFE is available with a range of fillers such as glass fibre and carbon which are used to improve certain properties of PTFE. Filled PTFE does not have the same levels of purity as virgin material.
- **Re-Processed PTFE** - Consists of virgin PTFE blended with a very fine powder of ground PTFE scrap and is used to reduce cost. Re-processed PTFE does not have the same levels of purity as virgin material.
- **Paste Extruded PTFE** - PTFE processed by paste extrusion may contain residues arising from the lubricant used in the extrusion process.
- **PFA** - has a more homogeneous structure than PTFE, can exhibit a better extractable performance than PTFE, however, this may be offset by the possibility of metal contamination arising from the moulding tools used to process PFA.
- **FEP** - similar purity properties to PFA.

SOLUBILITY

PTFE is generally regarded as being completely insoluble in all media except under very extreme conditions of temperature and pressure.

Contamination due to dissolution will not be an issue when using PTFE.

Exceptions include –

- Dissolution of PTFE has been reported in materials such as cyclic polyfluorocarbon oligomers at 300°C at atmospheric pressure.
- Under suitable conditions of temperature and pressure dissolution of PTFE has been observed in some perfluorocarbons, perfluorocarbon ethers, sulphur hexafluoride and carbon dioxide. Dissolution of PTFE in these types of solvent, followed by precipitation of the substrate has been used to prepare specialised forms of PTFE.
- Swelling of PTFE has been reported with benzyl chloride but without chemical reaction.

PTFE – NO Dissolution.....NO Contamination

Teflon® is a registered trademark of E.I. duPont de Nemours, Dyneon® is a registered trademark of 3M.
Diakin® is a registered trademark of Diakin Industries Ltd.

For further technical information and support on PTFE and it's applications,
please contact us at enquiries@cowie.com.

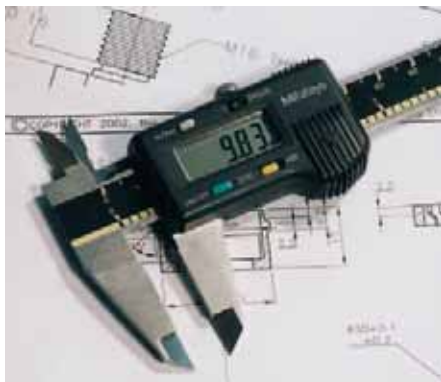

We are specialist manufacturers of PTFE products and produce custom products in endless variety to meet the demands of laboratory and process chemistry application. Custom products manufactured by COWIE® are supplied around the world ranging from one-offs through to continuous large volume supply. Our service covers the supply of Custom and OEM PTFE products ranging from simple items through to original design, development, product testing and evaluation and packaging.

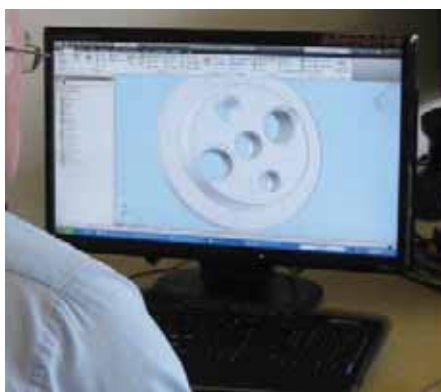

Our design & manufacturing facility is supported by the most up-to-date machining and moulding capability backed by our team of Mechanical Engineers, Chemical Engineers and Chemists dedicated solely to the technology of PTFE Processing and PTFE Product Application.

Moulding & Fusion

All of our PTFE materials are moulded in-house where we use a combination of compression, isostatic and fusion moulding to give near finished stock shapes plus fully finished, unmachinable and encapsulated products. In-house moulding to near finished size gives reduced material and machining costs as well as full traceability to original raw materials.



Machining

Our machining department provides expertise in milling, turning, grinding and CAD-CAM backed by a complement of CNC, turning, milling, multi-axis machinery and specialist inspection equipment. The use of near finished size mouldings reduces machine times and leads to significant cost reductions.

Technical

Our research and development department supports manufacturing processes, applications, new products and new technology and is equipped with an in-house tool room, laboratory and test facilities.

Quality Control & Assurance

As an ISO9001:2008 certified organisation, we operate standard operating procedures for product quality control and traceability.

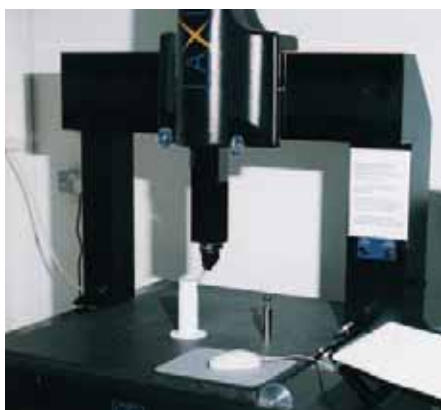

Typical Custom & OEM Products include Stopcock Plugs, Stirrer magnets, Sensors, Seals, Plungers, Pistons, Reaction vessels, Low temperature storage, Micro titre plates, Stoppers, Valves, Micro reactors, Gas spargers, In-line filters, Adapters, Connectors, Pump bodies, Encapsulated springs, Flow meter bodies, Digestors, Ultra pure containers, Sample holders, Heat shields, Shaft stirrers, Tamper proof fasteners and Strainers.

For further information or to send your enquiry for Custom PTFE Manufacture please email enquiries@cowie.com.

Distributed by



Australia Head Office

PO BOX 465
Blackburn, VIC 3130
Free Call: 1800 723 405
Ph: (03) 9845 0300
Fax: + 613 9845 0350
e-mail: sales@pacificlab.com.au

www.pacificlab.com.au

 /PacificLabP  @PacificLabP

Europe, Africa, Asia & Australasia

**Cowie Technology Group Ltd
Ridgeway, Coulby Newham
Middlesbrough
TS8 0TQ
England**

**Tel: +44 (0)1642 599190
Fax: +44 (0)1642 596810**

**enquiries@cowie.com
www.cowie.com**

USA & Canada

**Cowie Technology Corp
PO Box 6036
330 Water Street, Suite 105
Wilmington, DE 19804
USA**

**Toll Free: 800 233 5711
Tel: 001 302 998 7037
Fax: 001 302 998 7092**

**inquiries@cowie.com
www.cowie.com**